

Delivering Security For Every Industry



PRICE LIST

Effective January 7, 2026



NOTES

TABLE OF CONTENTS

Finish Cross Reference Chart	7
Order Conditions	8
Warranties	9
Minimum Advertising Policy (MAP)	9
Standards and Certifications	10

Life Safety and Security Door Hardware

ADVANTEK (Superior Heavy Duty Exit Devices)

Rim Exit Devices	
(10 Series Wide & 40 Series Narrow).....	12
Surface Vertical Rod Exit Devices	
(20 Series Wide & 50 Series Narrow).....	13
Surface Vertical Rod Exit Devices - Top Rod Only	
(21 Series Wide & 51 Series Narrow).....	14
High Security Surface Vertical Rod (27 Series).....	15
Mortise Lock Exit Device (30 Series).....	16
Narrow Concealed Vertical Rod Exit Devices	
(60 Series & 62 Series)	17
Narrow Concealed Vertical Rod Exit Devices - Top Rod Only	
(61 Series & 63 Series)	18
Wide Concealed Vertical Rod Exit Devices	
(70 Series, 80 Series & 82 Series)	19
Wide Concealed Vertical Rod Exit Devices - Top Rod Only	
(71 Series, 81 Series & 83 Series)	20
High Security Concealed Vertical Rod (87 Series).....	21
Dummy Exit Devices	
(00 Series, 05 Series, 01 Series & 04 Series).....	22
Electric Unlock Trims	23
Plates & Pull Trims	24
Lever Trims.....	26
FSB Levers.....	28
Advantex Trim Cross Reference Matrix.....	30
Advantex Exit Device Cross Reference Matrix.....	33
Advantex Electrified Options Cross Reference Matrix.....	34
Electrified Options	35
Parts & Accessories.....	42

TABLE OF CONTENTS

VALUESERIES® (Premium Economical Exit Devices)

Rim Exit Device (V40 Series & V40xNS Series)	46
Surface Vertical Rod Exit Device (V50 Series & V51 Series).....	47
Surface Vertical Rod Exit Device - Top Rod Only (V51 Series & V51xNS Series).....	48
Electric Unlock Trim.....	49
Plates & Pull Trims	50
Lever Trims.....	52
Value Series Exit Device Cross Reference Matrix.....	54
Value Series Trim Cross Reference Matrix.....	54
Value Series Electrified Options Cross Reference Matrix	55
Electrified Options	56
Parts & Accessories	62

PS80 SERIES™

Power Supplies.....	66
---------------------	----

Series 800

Power Supplies.....	66
Power Supply Logic Controllers	68
Power Supply Accessories	69

Mullions

90 Series	70
-----------------	----

AO19 SERIES® (Low Energy Automatic Door Operators)

How to Order	72
AO19-1 (Single Door).....	73
AO19-2 (Pair of Doors).....	74
AO19-3 (Double Egress Doors).....	75
AO19 Parts/Accessories.....	77

TABLE OF CONTENT

ECL™ (Exit Control Locks)

Exit Control Locks (ECL-230D, ECL-600)	85
Accessories (ECL-230D, ECL-600).....	86
Keepers and Strike Kits	87
Multi-Point Security (ECL-230DxVRA)	88
Exit Control Locks (ECL-230X Single Point Lock)	89
Exit Control Locks (ECL-230X 2-Point Lock)	90
Exit Control Locks (ECL-230X 3-Point Lock)	91
Exit Control Locks Trim (ECL-230X)	92
Hinge Side Bolts (DX1, DX2, DX3)	92
Exit Control Locks Accessories (ECL-230X)	93

Cylinders and Accessories	94
Rim or Mortise Cylinder?	95

EAX® (Exit Alarms)

Exit Alarms - EAX-500	96
Exit Alarms - EAX-2500	97
Exit Alarms - EAX-3500	98
Door Prop Alarms (EAX-300 Series and EAX-411 Series).....	99
Remote Alarms (CS-900 and CS-2900)	100
Door Switches	101
Accessories	102
Power Sources	103

AT-5000 SERIES™















Tailgate Detection	104
--------------------------	-----

TABLE OF CONTENTS (cont'd.)

Miscellaneous

Keyswitches and Covers	105
Push Buttons	106
Electric Strikes.....	106
Relay Kits	107
Power Transfers/Electric Hinges	107
Remote Indicating Panels.....	107
Motion Sensor	108
Electromagnetic Locks	108
Horns.....	108
Helpful Links	109

FINISH CROSS REFERENCE CHART

BHMA	US	Description	BHMA	US	Description
	605 US3	Brass, bright - PVD		628 US28	Aluminum, satin
	606 US4	Brass, satin - PVD		629 US32	Stainless Steel, bright
	611 US9	Bronze, bright - PVD		630 US32D	Stainless Steel, satin
	612 US10	Bronze, satin - PVD		689 SP28	Lacquer-sprayed Aluminum
	613 US10B	Bronze, oil-rubbed		693 SPBLK	Black, painted
	625 US26	Chromium, bright (See Detex trims)		695 SP313	Dark Bronze, painted
	626 US26D	Chromium, satin		711 DC35	Anodized Aluminum, black

ORDER CONDITIONS

Prices: Prices are subject to change without notice. **No prices are guaranteed;** all shipments will be made at prices prevailing at the time of receipt of order.

Terms: Net 30 days. Past due accounts may be subject to a shipping hold.

Acceptance: We reserve the right to decline an order, in whole or part, when the type or quantity of goods or creditworthiness of the purchaser is not satisfactory.

FOB Shipping Point: Buyer assumes ownership and responsibility for the goods at the seller's shipping location, typically the seller's loading dock or warehouse.

Delivery: All shipments are Ex Works* Factory New Braunfels, Texas. Freight allowance (ground service only) will be based on **individual shipments of \$12,000 or more in product in the contiguous U.S. and Canada (\$20,000 for international orders).** **Fees, taxes, and shipping costs do not count toward freight allowance.**

***Ex Works:** It is the buyer's responsibility to get Detex products from the Detex factory to the buyer's warehouse. The buyer can appoint a shipping and freight-forwarding company to collect goods from the Detex factory and transport them to the buyer's warehouse, including insurance of goods.

Credit Card Payments:

Effective May 1, 2023

A fee of 3% will be applied when using credit cards for payment.

Returned Goods: Materials may be returned for credit within **six (6) months** of purchase with approval from Detex. No goods will be accepted for return unless a **Return Materials Authorization** has been issued. Contact your local representative or factory with requests. **Returns must be unopened and in original packaging.** Credit will be issued at price paid or current price, whichever is lower, less a minimum 30% restocking charge. **Obsolete, discontinued or special products are not returnable.**

Special Order Items: Detex Custom Engineered EasyKits, products made for a specific customer requirement and other specialized one-of-a-kind products are **non-returnable** and **non-cancelable**, and may require a prepayment of 50%. Exit devices can be precut at factory for \$140.

Cancellation & Changes: If orders have been entered for manufacturing, cancellations cannot be accepted without our permission and may be subject to a cancellation charge.

Corrections: We expressly reserve the right to correct clerical, stenographic and other obvious errors at any time.

**TOLL FREE NUMBER FOR PLACING ORDERS DIRECTLY TO
OUR SALES DEPARTMENT**

1-800-729-3839

or e-mail

orders@detex.com

For the name of the representative / sales office in your area,
see Local Sales Offices at www.detex.com



Detex products can expose you to chemicals including Chromium (hexavalent compounds) and Lead, which are known to the State of California to cause cancer and birth defects or other reproductive harm. For more information go to www.detex.com/prop65

WARRANTIES

DETEX LIMITED WARRANTY

The Detex product you have purchased is warranted to be free of defects in material and workmanship when properly applied, installed, used and maintained according to Detex installation instructions and maintenance manual. We will guarantee mechanical and electrical components and repair or replace any part that, upon our examination, proves to be defective under normal use and has failed to properly operate as designed. This does not apply to batteries or damage from leaking batteries.

STANDARD WARRANTY PERIOD: 10 years mechanical, 3 years electrical from date of purchase

EXCEPTIONS TO STANDARD WARRANTY PERIOD:

- 3 years mechanical, 1 year electrical on AO19 Low Energy Operators, EAX Exit Alarms, BE Battery Eliminator, Series 800 Power Supplies and Controllers, DTX Access Control and MS Magnetic Switches
- 3 years mechanical on VRA 2-point vertical rods, 90KR and 90 mullions

This warranty will be honored only upon presentation of proof that the product covered thereby was purchased directly from an authorized Detex Distributor. WE SHALL NOT BE LIABLE FOR ANY DIRECT, INCIDENTAL OR CONSEQUENTIAL LOSS OR DAMAGE ARISING OUT OF THE FAILURE OF THIS DEVICE.

NOT UNDER WARRANTY FOR WEATHERIZED AND NON-WEATHERIZED DOOR HARDWARE PRODUCTS

Specifically excluded and not covered under this warranty are (1) the effects of corrosion, erosion and normal wear and tear, (2) cosmetic damage to exit device finishes, including scratches, dents, chips and other similar damage, unless such damage results from defects in materials and workmanship, and (3) exposure to extreme climate changes or harsh chemicals.

The service life and appearance of finishes of most Detex products can be degraded if the product is used in certain environments that are subject to extreme climate changes or exposure to the presence of harsh chemicals. The conscientious performance of a comprehensive maintenance program on a regular basis will help to maximize the service life and preserve the appearance of the product. Information about recommended maintenance procedures can be found at

www.detex.com/maintenance

For full warranty information, including warranty for finish & weatherized products, see www.detex.com/warranty

Minimum Advertised Price (MAP) Policy

Detex has established a Minimum Advertised Price (MAP) policy for select products within this price book.

The MAP policy currently applies to the following products:

V40 EB
ECL-230D
EAX-500

For more information, visit www.detex.com/map

Look for this symbol

MAP Policy Applies
See page 9

STANDARDS AND CERTIFICATIONS

Product	Type	Application	Fire Rated Openings	Certification Listing		Windstorm Listing	Mortise Cylinder Required	Limited Warranty
Advantex								
10 Series	Relatching Lock	Rim Exit	Yes*, 3hr UL Listed	UL Listed panic hardware	4140-0127:0105 3774-0127:0106 3725-0127:0108	FBC**	CD, EA, EI, EE, & EE ER	10/3 years
20 Series	Relatching 2-point Lock	SVR	Yes*, 3hr UL Listed	UL Listed panic hardware	4140-0127:0105 3774-0127:0106 3725-0127:0108	FBC**	CD, EA, EE, & EE ER	10/3 years
21 Series	Relatching Lock	SVR Top Rod Only	Yes*, 3hr UL Listed	UL Listed panic hardware	4140-0127:0105 3774-0127:0106 3725-0127:0108	No	CD, EA, EE, & EE ER	10/3 years
27 Series	Heavy Duty 2-point Relatching Lock	SVR	Yes*, 3hr UL Listed	UL Listed panic hardware	No	FEMA 361***	CD, EA, EE, & EE ER	10/3 years
30 Series	Mortise Lock	Mortise Exit Device	Yes*, 3hr UL Listed	UL Listed panic hardware	4140-0127:0105 3774-0127:0106 3725-0127:0108	No	CD, EA, EE, & EE ER	10/3 years
40 Series	Relatching Lock	Narrow Stile Rim Exit Device	Yes*, 3hr UL Listed	UL Listed panic hardware	4140-0127:0105 3774-0127:0106 3725-0127:0108	FBC**	CD, EA, EI, EE, & EE ER	10/3 years
50 Series	Relatching 2-point Lock	Narrow Stile SVR	Yes*, 3hr UL Listed	UL Listed panic hardware	4140-0127:0105 3774-0127:0106 3725-0127:0108	FBC**	CD, EA, EE, & EE ER	10/3 years
51 Series	Relatching Lock	Narrow Stile SVR Top Rod Only	Yes*, 3hr UL Listed	UL Listed panic hardware	4140-0127:0105 3774-0127:0106 3725-0127:0108	No	CD, EA, EE, & EE ER	10/3 years
60 Series	Relatching 2-point Lock	CVR for Aluminum Doors	Yes*, 3hr UL Listed	UL Listed panic hardware	4140-0127:0110 3774-0127:0106 3725-0127:0108	No	CD, EA, EE, & EE ER	10/3 years
61 Series	Relatching Lock	CVR for Aluminum Doors Top Rod Only	Yes*, 3hr UL Listed	UL Listed panic hardware	4140-0127:0110 3774-0127:0106 3725-0127:0108	No	CD, EA, EE, & EE ER	10/3 years
62 Series	Relatching 2-point Lock	CVR for Hollow Metal Doors	Yes*, 3hr UL Listed	UL Listed panic hardware	4140-0127:0110 3774-0127:0106 3725-0127:0108	No	CD, EA, EE, & EE ER	10/3 years
63 Series	Relatching Lock	CVR for Hollow Metal Doors Top Rod Only	Yes*, 3hr UL Listed	UL Listed panic hardware	4140-0127:0110 3774-0127:0106 3725-0127:0108	No	CD, EA, EE, & EE ER	10/3 years
70 Series	Relatching 2-point Lock	CVR for Wood Doors	Yes* 90 Min WH/ ETL Listed	UL Listed panic hardware	4140-0127:0110 3774-0127:0106 3725-0127:0108	No	CD, EA, EE, & EE ER	10/3 years
71 Series	Relatching Lock	CVR for Wood Doors Top Rod Only	Yes* 90 Min WH/ ETL Listed	UL Listed panic hardware	4140-0127:0110 3774-0127:0106 3725-0127:0108	No	CD, EA, EE, & EE ER	10/3 years
80 Series	Relatching 2-point Lock	CVR for Hollow Metal Doors	Yes*, 3hr UL Listed	UL Listed panic hardware	4140-0127:0110 3774-0127:0106 3725-0127:0108	No	CD, EA, EE, & EE ER	10/3 years
81 Series	Relatching Lock	CVR for Hollow Metal Doors Top Rod Only	Yes*, 3hr UL Listed	UL Listed panic hardware	4140-0127:0110 3774-0127:0106 3725-0127:0108	No	CD, EA, EE, & EE ER	10/3 years
82 Series	Relatching 2-point Lock	CVR for Aluminum Doors	Yes*, 3hr UL Listed	UL Listed panic hardware	4140-0127:0110 3774-0127:0106 3725-0127:0108	No	CD, EA, EE, & EE ER	10/3 years
83 Series	Relatching Lock	CVR for Aluminum Doors Top Rod Only	Yes*, 3hr UL Listed	UL Listed panic hardware	4140-0127:0110 3774-0127:0106 3725-0127:0108	No	CD, EA, EE, & EE ER	10/3 years
87 Series	Heavy-Duty 2-point Relatching Lock	CVR	Yes*, 3hr UL Listed	UL Listed panic hardware	No	FEMA 361***	CD, EA, EE, & EE ER	10/3 years
Value Series								
V40 Series	Relatching Lock	Rim Exit Device	Yes*, 3hr UL Listed	UL Listed panic hardware	4140-0127:0105 3774-0127:0106 3725-0127:0108	FBC**	CD, EB(W), EE, & EI	10/3 years
V50 Series	Relatching 2-point Lock	SVR	Yes*, 3hr UL Listed	UL Listed panic hardware	4140-0127:0105 3774-0127:0106 3725-0127:0108	FBC**	CD, EB(W), & EE	10/3 years
V51 Series	Relatching Lock	SVR Top Rod Only	Yes*, 3hr UL Listed	UL Listed panic hardware	4140-0127:0105 3774-0127:0106 3725-0127:0108	No	CD, EB(W), & EE	10/3 years

STANDARDS AND CERTIFICATIONS

Product	Type	Application	Fire Rated Openings	Certification Listing		Windstorm Listing	Cylinder Type Required	Limited Warranty
AO19 Series	Low Energy Automatic Operator	Single, Pairs, and Double Egress Doors	WH Listed Fire Exit Hardware	ETL Listed ANSI 156.19	N/A	N/A	N/A	3/1 years
90KR	Keyed Removable Mullion	Pairs of Doors	3hr WH/ Intertek listed*	UL Listed	N/A	No	Rim	3 years
90R	Removable Mullions	Pairs of Doors	Contact Factory	UL Listed	N/A	FBC**	N/A	3 years
ECL-230D	Deadbolt Lock	9V Alarm	No	UL Listed panic hardware	4140-0127:0102	No	Rim	10/3 years
ECL-230D-PH	Deadbolt Lock	9V Alarm	No	UL Listed panic hardware	4140-0127:0102	No	Rim	10/3 years
ECL-230X	Deadbolt Lock	9V Alarm	No	UL Listed panic hardware	4140-0127:0109	FBC**	Rim	10/3 years
ECL-230X-TD	2-Point Deadbolt Lock	9V Alarm	No	UL Listed panic hardware	4140-0127:0109	No	Rim	10/3 years
ECL-230X-TB	SVR Non-Relatching Lock	9V Alarm	No	UL Listed panic hardware	4140-0127:0109	No	Rim	10/3 years
ECL-230X-TDB	3-Point Deadbolt Lock	9V Alarm	No	UL Listed panic hardware	4140-0127:0109	FBC**	Rim	10/3 years
ECL-600	Deadbolt & Relatching 2-Point Lock	9V Alarm	3hr WH/ETL listed	ETL Listed panic hardware	N/A	No	Rim	10/3 years
VRA-143	2-Point Vertical Rod Deadbolt Lock	N/A	No	UL Listed exit lock	N/A	No	N/A	3 years
EAX-300	Door Prop Alarm	9V Alarm	Yes§	ANSI 156.29 Listed	N/A	¶	Mortise	3/1 years
EAX-500	Door Mount Alarm	9V Alarm	Yes§	ANSI 156.29 Listed	N/A	¶	Mortise	3/1 years
EAX-2500	Wall Mount Door Alarm	12-24VAC Alarm	¶	ANSI 156.29 Listed	N/A	N/A	Mortise	3/1 years
EAX-3500	Timed Bypass Exit Alarm	24VAC / VDC Alarm	¶	N/A	N/A	N/A	Mortise	3/1 years
BE-961	Power Supply	9VDC Power Supply	∞	N/A	N/A	¶	N/A	3/1 years
Series 800	Power Supplies & Logic Controllers	Power Supplies w/ Logic	∞	UL Listed	3774-0127:0107	N/A	N/A	3/1 years
MS-2049	Magnetic Door Switch	Industrial grade	Yes§	UL Listed	N/A	N/A	N/A	3/1 years
MS-1039/59	Magnetic Switch	Standard grade	No	UL Listed	N/A	N/A	N/A	3/1 years
DTX Series	Access Keypad / Card Readers	Access Control	∞	N/A	N/A	N/A	N/A	3/1 years
D-4550	Door Closers	Single Doors	Yes	UL Listed	N/A	N/A	N/A	10 years

* Add Prefix "F" for Fire Exit Hardware

**Add Prefix "H" for Florida Building Code Hurricane component

*** Add prefix "T" for FEMA rated hardware

For detailed windstorm and fire listings, visit detex.com/PROVEN

¶ Wall mounted - may be used with Rated Openings - use fire door accessory (see MS-2049)

∞ Allowed with fire-rated doors, but product itself is not fire-rated

§ UL Listed Miscellaneous Fire Door Accessory

10/3 year warranty = 10-year limited warranty on mechanical components

3-year limited warranty on electrical components

3/1 year warranty = 3-year limited warranty on mechanical components

1-year limited warranty on electrical components



10 Series Wide Stile Rim



40 Series Narrow Stile Rim

Device	Finishes				
	630 (Std.)	628	693, 695	606, 612	605, 611, 613, 629
10 Series	\$2,408	\$2,082	\$2,133	\$2,730	\$2,850
40 Series	\$2,618	\$2,311	\$2,472	\$2,851	\$3,061

To order trim with exit device, specify exit device followed by trim (ex. 1008D, 4008DN). See pages 23-29 for trims.

10 SERIES DEVICE COMES STANDARD WITH

- * Same finish, device exterior (except 628 finish which includes stainless steel cover, pushpad and endcap)
- * EC1 Ramped Endcap - Heavy Duty
- * Hex Dogging
- * 36" Device for 3-foot doors
- * 99 Surface Strike

40 SERIES DEVICE COMES STANDARD WITH

- * Same finish, device exterior (except 628 finish which includes stainless steel cover, pushpad and endcap)
- * EC1 Ramped Endcap - Heavy Duty
- * Hex Dogging
- * 36" Device for 3-foot doors
- * 98 Semi-Mortise Strike
- * Extended Extrusion

OPTIONS

LIST PRICE

F - Fire-Rated	\$225
H - Hurricane Rated	\$125
FH - Fire-Rated/Hurricane Rated	\$350
W - Weatherized (mechanical only)	\$225
Custom Lengths (Specify size - min. 24", max 48")	\$160
48" - Add for 4-foot door width	\$50
60" - Add for 5-foot door width (10 Series only) - 628, 693, 695 finishes only	\$353
EC2 - Flush endcap	N/C*
SN1 - Sex Nuts / Throughbolts	\$29/set
-10 Series Device with trim requires 1 set	
-10 Series Device only requires 3 sets	
-40 Series Device with trim requires 1 set	
-40 Series Device only requires 2 sets	
AM - Antimicrobial (pushpad only)	\$96
KS - Keystop installed (alarm always armed when key removed)	\$11
SLR - Silent pushpad return	\$96
CD - Cylinder Dogging	N/C*
LD - Less Dogging	N/C*
94 - Double Door Strike (wide stile doors only)	N/C*
99 - Surface Strike (40 Series only)	N/C*
98 - Semi-Mortise Strike (10 Series only)	N/C*

*No cost when ordered with device

NOTE - Cylinders not included. Products on this page can be ordered with cylinders (C65) or Interchangeable core housings (IC7) pre-installed at Detex prior to shipping (See page 94).

NOTE - See Electrified Options for availability on devices shorter than 30", certain sizes come with EC2 endcap.



How To Orders



Pulls & Plates
Page 24



Lever Trims
Page 26



Electrified Options
Page 35

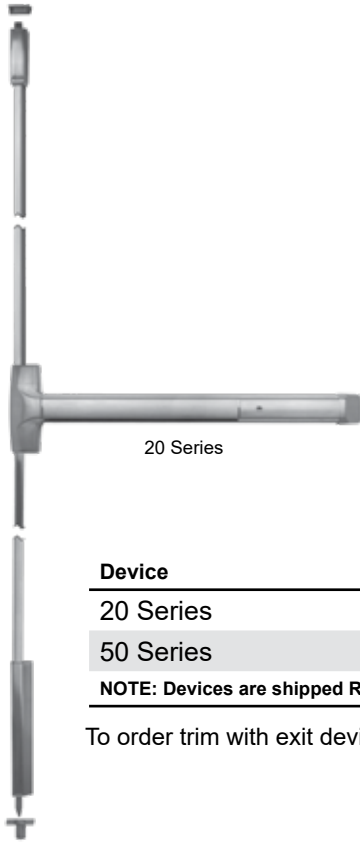

20 Series

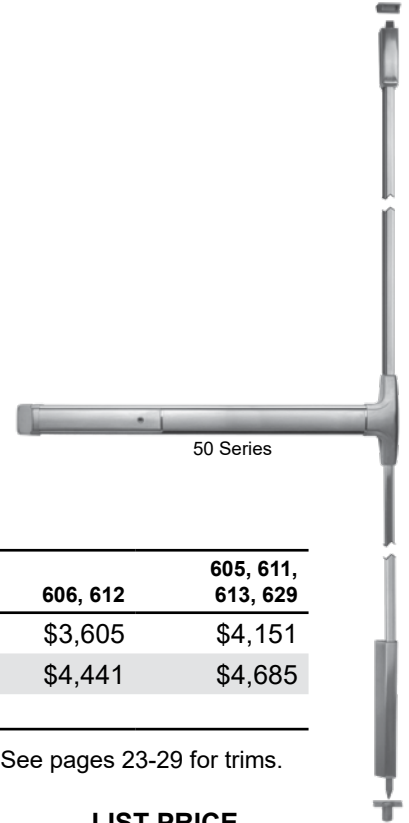

50 Series

Finishes

Device	630 (Std.)	628	693, 695	606, 612	605, 611, 613, 629
20 Series	\$3,558	\$3,087	\$3,379	\$3,605	\$4,151
50 Series	\$4,166	\$3,554	\$3,870	\$4,441	\$4,685

NOTE: Devices are shipped RHR unless specified LHR (Field Reversible)

To order trim with exit device, specify exit device followed by trim (ex. 2003C, 5003CN). See pages 23-29 for trims.

20 SERIES DEVICE COMES STANDARD WITH

- * Rod, Latch and ADA Bottom Bolt Covers
- * Same finish, device exterior (except 628 finish which includes stainless steel cover, pushpad and endcap)
- * EC1 Ramped Endcap - Heavy Duty
- * Hex Dogging
- * 36" Device for 3-foot doors
- * 84" Rods for 7-foot doors
- * 97 Surface Strike
- * 97 Dustproof Bottom Strike

50 SERIES DEVICE COMES STANDARD WITH

- * Rod Covers
- * Same finish, device exterior (except 628 finish which includes stainless steel cover, pushpad and endcap)
- * EC1 Ramped Endcap - Heavy Duty
- * Hex Dogging
- * 36" Device for 3-foot doors
- * 84" Rods for 7-foot doors
- * 96 Surface Strike
- * 96 Dustproof Bottom Strike
- * Extended Extrusion



How To Orders

OPTIONS

LIST PRICE

F - Fire-Rated	\$225
H - Hurricane Rated	\$125
FH - Fire-Rated/Hurricane Rated	\$350
W - Weatherized (mechanical only)	\$225
Custom Lengths (Specify size - min. 24", max 48")	\$160
48" - Add for 4-foot door width	\$50
96" - Add for 8-foot door height	\$118
120" - Add for 10-foot door height	\$118
EC2 - Flush endcap	N/C*
SN1 - Sex Nuts / Throughbolts	\$29/set
-20 Series Device with trim requires 3 sets	
-20 Series Device only requires 5 sets	
-50 Series Device with trim requires 3 sets	
-50 Series Device only requires 4 sets	
AM - Antimicrobial (pushpad only)	\$96
KS - Keystop installed (alarm always armed when key removed)	\$11
SLR - Silent pushpad return	\$96
CD - Cylinder Dogging	N/C*
LD - Less Dogging	N/C*

*No cost when ordered with device

NOTE - Cylinders not included. Products on this page can be ordered with cylinders (C65) or Interchangeable core housings (IC7) pre-installed at Detex prior to shipping (See page 94).

NOTE - See Electrified Options for availability on devices shorter than 30", certain sizes come with EC2 endcap.

NOTE - Application NOTE for 2' device (Available on Surface Vertical Device. Will ship less UL Fire label):

When vertical rod devices are used on both doors of a pair, operation of the inactive door (smaller door) will not disengage the active door, creating a potential safety issue for those using the inactive door during an emergency.





21 Series
Top Rod Only



51 Series
Top Rod Only

Device	Finishes				
	630 (Std.)	628	693, 695	606, 612	605, 611, 613, 629
21 Series	\$3,558	\$3,087	\$3,379	\$3,605	\$4,151
51 Series	\$4,166	\$3,554	\$3,870	\$4,441	\$4,685

NOTE: Devices are shipped RHR unless specified LHR (Field Reversible)

To order trim with exit device, specify exit device followed by trim (ex. 2103C, 5103CN). See pages 23-29 for trims.

21 SERIES DEVICE COMES STANDARD WITH

- * Rod Covers
- * Same finish, device exterior (except 628 finish which includes stainless steel cover, pushpad and endcap)
- * EC1 Ramped Endcap - Heavy Duty
- * Hex Dogging
- * 36" Device for 3-foot doors
- * 84" Rods for 7-foot doors
- * 97 Surface Strike

51 SERIES DEVICE COMES STANDARD WITH

- * Rod Covers
- * Same finish, device exterior (except 628 finish which includes stainless steel cover, pushpad and endcap)
- * EC1 Ramped Endcap - Heavy Duty
- * Hex Dogging
- * 36" Device for 3-foot doors
- * 84" Rods for 7-foot doors
- * 96 Surface Strike
- * Extended Extrusion

OPTIONS

LIST PRICE

F - Fire-Rated	\$225
H - Hurricane Rated	\$125
FH - Fire-Rated/Hurricane Rated	\$350
W - Weatherized (mechanical only)	\$225
Custom Lengths (Specify size - min. 24", max 48")	\$160
48" - Add for 4-foot door width	\$50
96" - Add for 8-foot door height	\$118
120" - Add for 10-foot door height	\$118
EC2 - Flush endcap	N/C*
SN1 - Sex Nuts / Throughbolts	\$29/set
-21 Series Device with trim requires 2 sets	
-21 Series Device only requires 4 sets	
-51 Series Device with trim requires 2 sets	
-51 Series Device only requires 3 sets	
AM - Antimicrobial (pushpad only)	\$96
KS - Keystop installed (alarm always armed when key removed)	\$11
SLR - Silent pushpad return	\$96
CD - Cylinder Dogging	N/C*
LD - Less Dogging	N/C*

*No cost when ordered with device

NOTE - Cylinders not included. Products on this page can be ordered with cylinders (C65) or Interchangeable core housings (IC7) pre-installed at Detex prior to shipping (See page 94).

NOTE - See Electrified Options for availability on devices shorter than 30", certain sizes come with EC2 endcap.

NOTE - Application NOTE for 2' device (Available on Surface Vertical Device. Will ship less UL Fire label):

When vertical rod devices are used on both doors of a pair, operation of the inactive door (smaller door) will not disengage the active door, creating a potential safety issue for those using the inactive door during an emergency.



How To Orders



Pulls & Plates
Page 24



Lever Trims
Page 26



Electrified
Options
Page 35

27 SERIES ROD COVERS SOLD SEPARATELY

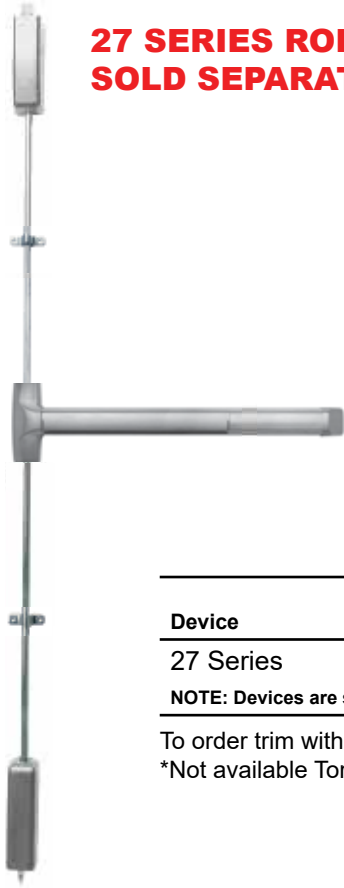

27 SERIES DEVICE COMES STANDARD WITH

- * Latch Covers
- * Same finish, device exterior (except 628 finish which includes stainless steel pushpad and endcap)
- * EC1 Ramped Endcap - Heavy Duty
- * Hex Dogging
- * 36" Device for 3-foot doors
- * 84" Device for 7-foot doors



How To Orders

Finishes

Device	630 (Std.)	628*	693, 695	606, 612	605, 611, 613, 629
27 Series	\$4,728	\$4,470	\$4,470	\$4,997	\$5,945

NOTE: Devices are shipped RHR unless specified LHR (Field Reversible)

To order trim with exit device, specify exit device followed by trim (ex. 2701C). See pages 23-29 for trims.

*Not available Tornado Rated

OPTIONS

LIST PRICE

T - Tornado Rated (max 42" wide and 88" tall)	\$90
F - Fire-Rated	\$225
W - Weatherized (mechanical only)	\$225
Custom Lengths (Specify size - min. 24", max 48")	\$160
48" - Add for 4-foot door width	\$50
96" - Add for 8-foot door height	\$118
120" - Add for 10-foot door height	\$118
EC2 - Flush endcap	N/C*
SN1 - Sex Nuts / Throughbolts -Device with trim requires 1 sets -Device only requires 3 sets	\$29/set
AM - Antimicrobial (pushpad only)	\$96
KS - Keystop installed (alarm always armed when key removed)	\$11
SLR - Silent pushpad return	\$96
CD - Cylinder Dogging	N/C*
LD - Less Dogging	N/C*

*No cost when ordered with device

NOTE - Cylinders not included. Products on this page can be ordered with cylinders (C65) or Interchangeable core housings (IC7) pre-installed at Detex prior to shipping (See page 94).

NOTE - See Electrified Options for availability on devices shorter than 30", certain sizes come with EC2 endcap.

NOTE - When vertical rod devices are used on both doors of a pair, operation of the inactive door (smaller door) will not disengage the active door, creating a potential safety issue for those using the inactive door during an emergency.



Pulls & Plates
Page 24



Lever Trims
Page 26



Electrified
Options
Page 35



Device	Finishes				
	630 (Std.)	628	693, 695	606, 612	605, 611, 613, 629
30 Series	\$3,428	\$3,035	\$3,226	\$3,456	\$4,024

To order trim with exit device, specify exit device followed by trim (ex. 3002DM). See pages 23-29 for trims.

30 SERIES DEVICE COMES STANDARD WITH

- * Same finish, device exterior (except 628 finish which includes stainless steel cover, pushpad and endcap)
- * EC1 Ramped Endcap - Heavy Duty
- * Hex Dogging
- * 36" Device for 3-foot doors
- * 90 Non-Handed Curved Lip Strike



How To Orders

OPTIONS

LIST PRICE

F - Fire-Rated	\$225
Custom Lengths (Specify size - min. 24", max 48")	\$160
48" - Add for 4-foot door width	\$50
EC2 - Flush endcap	N/C*
SN1 - Sex Nuts / Throughbolts -Device with trim requires 1 set -Device only requires 3 sets	\$29/set
AM - Antimicrobial (pushpad only)	\$96
KS - Keystop installed (alarm always armed when key removed)	\$11
SLR - Silent pushpad return	\$96
CD - Cylinder Dogging	N/C*
LD - Less Dogging	N/C*
91 - ANSI Flat Lip Strike	N/C*
92 - Double Door Short Open Back Strike	N/C*
93 - Double Door Long Open Back Strike	N/C*

*No cost when ordered with device

NOTE - Cylinders not included. Products on this page can be ordered with cylinders (C65) or Interchangeable core housings (IC7) pre-installed at Detex prior to shipping (See page 94).

NOTE - See Electrified Options for availability on devices shorter than 30", certain sizes come with EC2 endcap.



Pulls & Plates
Page 24



Lever Trims
Page 26



Electrified
Options
Page 35

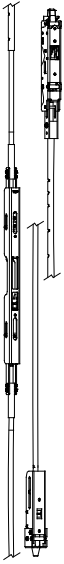

60 Series - For Aluminum Door
62 Series - For Hollow Metal Door

Device	Finishes				
	630 (Std.)	628	693, 695	606, 612	605, 611, 613, 629
60 Series	\$4,159	\$3,619	\$3,921	\$4,579	\$5,330
62 Series	\$4,159	\$3,619	\$3,921	\$4,579	\$5,330

NOTE: Devices are shipped RHR unless specified LHR (Field Reversible)

To order trim with exit device, specify exit device followed by trim (ex. 6001CNV, 6201CNV). See pages 23-29 for trims.

60 SERIES DEVICE COMES STANDARD WITH

- * Same finish, device exterior (except 628 finish which includes stainless steel cover, pushpad and endcap)
- * EC1 Ramped Endcap - Heavy Duty
- * Hex Dogging
- * 36" Device for 3-foot doors
- * 80" - 96" Fits 6'8" to 8' doors
- * 95T Top Strike
- * 95B Bottom Strike

62 SERIES DEVICE COMES STANDARD WITH

- * Same finish, device exterior (except 628 finish which includes stainless steel cover, pushpad and endcap)
- * 36" Device for 3-foot doors
- * EC1 Ramped Endcap - Heavy Duty
- * Hex Dogging
- * 80" - 96" Fits 6'8" to 8' doors
- * 95T Top Strike
- * 95B Bottom Strike

OPTIONS

LIST PRICE

F - Fire-Rated (3 hour) (steel door required for 60 Series)	\$225
Custom Lengths (Specify size - min. 24", max 48")	\$160
48" - Add for 4-foot door width	\$50
120" - Add for 10-foot door height	\$118
EC2 - Flush endcap	N/C*
SN1 - Sex Nuts / Throughbolts	\$29/set
-60 Series Device with trim requires 1 set long	
-60 Series Device only requires 1 set long and 1 set short	
-62 Series Device with trim requires 1 set long	
-62 Series Device only requires 1 set long and 1 set short	
AM - Antimicrobial (pushpad only)	\$96
KS - Keystop installed (alarm always armed when key removed)	\$11
SLR - Silent pushpad return	\$96
CD - Cylinder Dogging	N/C*
LD - Less Dogging	N/C*

*No cost when ordered with device

NOTE - Cylinders not included. Products on this page can be ordered with cylinders (C65) or Interchangeable core housings (IC7) pre-installed at Detex prior to shipping (See page 94).

NOTE - See Electrified Options for availability on devices shorter than 30", certain sizes come with EC2 endcap.



How To Orders



Pulls & Plates
Page 25



Lever Trims
Page 27



Electrified Options
Page 35



61 Series - For Aluminum Door
63 Series - For Hollow Metal Door

Device	Finishes				
	630 (Std.)	628	693, 695	606, 612	605, 611, 613, 629
61 Series	\$4,159	\$3,619	\$3,921	\$4,579	\$5,330
63 Series	\$4,159	\$3,619	\$3,921	\$4,579	\$5,330

NOTE: Devices are shipped RHR unless specified LHR (Field Reversible)

To order trim with exit device, specify exit device followed by trim (ex. 6101CNV, 6301CNV). See pages 23-29 for trims.

61 SERIES DEVICE COMES STANDARD WITH

- * Same finish, device exterior (except 628 finish which includes stainless steel cover, pushpad and endcap)
- * EC1 Ramped Endcap - Heavy Duty
- * Hex Dogging
- * 36" Device for 3-foot doors
- * 80" - 96" Fits 6'8" to 8' doors
- * 95T Top Strike

63 SERIES DEVICE COMES STANDARD WITH

- * Same finish, device exterior (except 628 finish which includes stainless steel cover, pushpad and endcap)
- * 36" Device for 3-foot doors
- * EC1 Ramped Endcap - Heavy Duty
- * Hex Dogging
- * 80" - 96" Fits 6'8" to 8' doors
- * 95T Top Strike

OPTIONS

LIST PRICE

F - Fire-Rated (3 hour) (steel door required for 61 Series)	\$225
Custom Lengths (Specify size - min. 24", max 48")	\$160
48" - Add for 4-foot door width	\$50
120" - Add for 10-foot door height	\$118
EC2 - Flush endcap	N/C*
SN1 - Sex Nuts / Throughbolts	\$29/set
-61 Series Device with trim requires 1 set long	
-61 Series Device only requires 1 set long and 1 set short	
-63 Series Device with trim requires 1 set long	
-63 Series Device only requires 1 set long and 1 set short	
AM - Antimicrobial (pushpad only)	\$96
KS - Keystop installed (alarm always armed when key removed)	\$11
SLR - Silent pushpad return	\$96
CD - Cylinder Dogging	N/C*
LD - Less Dogging	N/C*

*No cost when ordered with device

NOTE - Cylinders not included. Products on this page can be ordered with cylinders (C65) or Interchangeable core housings (IC7) pre-installed at Detex prior to shipping (See page 94).

NOTE - See Electrified Options for availability on devices shorter than 30", certain sizes come with EC2 endcap.



How To Orders



Pulls & Plates
Page 25



Lever Trims
Page 27



Electrified Options
Page 35

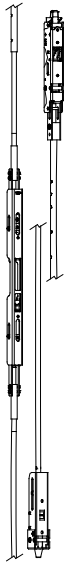

70 Series - For Wood Door
80 Series - For Hollow Metal Door
82 Series - For Aluminum Door

Device	Finishes				
	630 (Std.)	628	693, 695	606, 612	605, 611, 613, 629
70 Series	\$4,050	\$3,608	\$3,912	\$4,381	\$4,936
80 Series	\$4,050	\$3,608	\$3,912	\$4,381	\$4,936
82 Series	\$4,050	\$3,608	\$3,912	\$4,381	\$4,936

NOTE: Devices are shipped RHR unless specified LHR (Field Reversible)
NOTE: For high-security or high-traffic doors, 2" solid-core door recommended

To order trim with exit device, specify exit device followed by trim (ex. 7002CV, 8002CV, 8202CV). See pages 23-29 for trims.

70 SERIES DEVICE COMES STANDARD WITH

- * Same finish, device exterior (except 628 finish which includes stainless steel cover, pushpad and endcap)
- * 36" Device for 3-foot doors
- * EC1 Ramped Endcap - Heavy Duty
- * Hex Dogging
- * 80" - 96" Fits 6'8" to 8' doors
- * 95T Top Strike
- * 95B Bottom Strike

80 SERIES DEVICE COMES STANDARD WITH

- * Same finish, device exterior (except 628 finish which includes stainless steel cover, pushpad and endcap)
- * 36" Device for 3-foot doors
- * EC1 Ramped Endcap - Heavy Duty
- * Hex Dogging
- * 80" - 96" Fits 6'8" to 8' doors
- * 95T Top Strike
- * 95B Bottom Strike

82 SERIES DEVICE COMES STANDARD WITH

- * Same finish, device exterior (except 628 finish which includes stainless steel cover, pushpad and endcap)
- * 36" Device for 3-foot doors
- * EC1 Ramped Endcap - Heavy Duty
- * Hex Dogging
- * 80" - 96" Fits 6'8" to 8' doors
- * 95T Top Strike
- * 95B Bottom Strike

OPTIONS

LIST PRICE

F - Fire-Rated (70 Series - 90 minutes; 80 Series - 3 hour)	\$225
Custom Lengths (Specify size - min. 24", max 48")	\$160
48" - Add for 4-foot door width	\$50
120" - Add for door height 97" to 120"	\$118
EC2 - Flush endcap	N/C*
SN1 - Sex Nuts / Throughbolts	\$29/set
-70 Series Device with trim requires 1 set	
-70 Series Device only requires 3 sets	
-80 Series Device with trim requires 1 set	
-80 Series Device only requires 3 sets	
-82 Series Device with trim requires 1 set	
-82 Series Device only requires 3 sets	
AM - Antimicrobial (pushpad only)	\$96
KS - Keystop installed (alarm always armed when key removed)	\$11
SLR - Silent pushpad return	\$96
CD - Cylinder Dogging	N/C*
LD - Less Dogging	N/C*

*No cost when ordered with device

NOTE - Cylinders not included. Products on this page can be ordered with cylinders (C65) or Interchangeable core housings (IC7) pre-installed at Detex prior to shipping (See page 94).

NOTE - See Electrified Options for availability on devices shorter than 30", certain sizes come with EC2 endcap.



How To Orders



Pulls & Plates
Page 24



Lever Trims
Page 26



Electrified
Options
Page 35

71 Series - For Wood Door
81 Series - For Hollow Metal Door
83 Series - For Aluminum Door

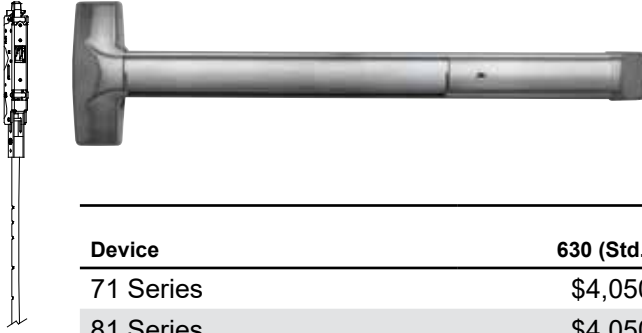

Device	Finishes				
	630 (Std.)	628	693, 695	606, 612	605, 611, 613, 629
71 Series	\$4,050	\$3,608	\$3,912	\$4,381	\$4,936
81 Series	\$4,050	\$3,608	\$3,912	\$4,381	\$4,936
83 Series	\$4,050	\$3,608	\$3,912	\$4,381	\$4,936

NOTE: Devices are shipped RHR unless specified LHR (Field Reversible)
NOTE: For high-security or high-traffic doors, 2" solid-core door recommended

To order trim with exit device, specify exit device followed by trim (ex. 7102CV, 8102CV, 8302CV). See pages 23-29 for trims.

71 SERIES DEVICE COMES STANDARD WITH

- * Same finish, device exterior (except 628 finish which includes stainless steel cover, pushpad and endcap)
- * 36" Device for 3-foot doors
- * EC1 Ramped Endcap - Heavy Duty
- * Hex Dogging
- * 80" - 96" Fits 6'8" to 8' doors
- * 95T Top Strike

81 SERIES DEVICE COMES STANDARD WITH

- * Same finish, device exterior (except 628 finish which includes stainless steel cover, pushpad and endcap)
- * 36" Device for 3-foot doors
- * EC1 Ramped Endcap - Heavy Duty
- * Hex Dogging
- * 80" - 96" Fits 6'8" to 8' doors
- * 95T Top Strike

83 SERIES DEVICE COMES STANDARD WITH

- * Same finish, device exterior (except 628 finish which includes stainless steel cover, pushpad and endcap)
- * 36" Device for 3-foot doors
- * EC1 Ramped Endcap - Heavy Duty
- * Hex Dogging
- * 80" - 96" Fits 6'8" to 8' doors
- * 95T Top Strike

OPTIONS

LIST PRICE

F - Fire-Rated (71 Series - 90 minutes; 81 Series - 3 hour) - Fire pin included	\$225
Custom Lengths (Specify size - min. 24", max 48")	\$160
48" - Add for 4-foot door width	\$50
120" - Add for door height 97" to 120"	\$118
EC2 - Flush endcap	N/C*
SN1 - Sex Nuts / Throughbolts -71 Series Device with trim requires 1 set -71 Series Device only requires 3 sets -81 Series Device with trim requires 1 set -81 Series Device only requires 3 sets -83 Series Device with trim requires 1 set -83 Series Device only requires 3 sets	\$29/set
AM - Antimicrobial (pushpad only)	\$96
KS - Keystop installed (alarm always armed when key removed)	\$11
SLR - Silent pushpad return	\$96
CD - Cylinder Dogging	N/C*
LD - Less Dogging	N/C*

*No cost when ordered with device

NOTE - Cylinders not included. Products on this page can be ordered with cylinders (C65) or Interchangeable core housings (IC7) pre-installed at Detex prior to shipping (See page 94).

NOTE - See Electrified Options for availability on devices shorter than 30", certain sizes come with EC2 endcap.



How To Orders



Pulls & Plates
Page 24



Lever Trims
Page 26



Electrified
Options
Page 35

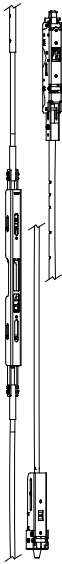

Device	Finishes				
	630 (Std.)	628*	693, 695	606, 612	605, 611, 613, 629
87 Series	\$5,467	\$5,161	\$5,161	\$5,970	\$6,622

NOTE: Devices are shipped RHR unless specified LHR (Field Reversible)
 NOTE: For high-security or high-traffic doors, 2" solid-core door recommended

To order trim with exit device, specify exit device followed by trim (ex. 8702WP). See pages 23-29 for trims.
 *Not available Tornado Rated

87 SERIES DEVICE COMES STANDARD WITH

- * Same finish, device exterior
- * 36" Device for 3-foot doors
- * EC1 Ramped Endcap - Heavy Duty
- * Hex Dogging
- * 80" - 96" Fits 6'8" to 8' doors
- * 995T Top Strike
- * 95B Bottom Strike



How To Orders

OPTIONS

LIST PRICE

T - Tornado Rated (max 42" wide and 88" tall)	\$90
F - Fire-Rated (Contact factory)	\$225
Custom Lengths (Specify size - min. 24", max 48")	\$160
48" - Add for 4-foot door width	\$50
120" - Add for door height 97" to 120"	\$118
EC2 - Flush endcap	N/C*
SN1 - Sex Nuts / Throughbolts -Device with trim requires 1 set -Device only requires 3 sets	\$29/set
AM - Antimicrobial (pushpad only)	\$96
KS - Keystop installed (alarm always armed when key removed)	\$11
SLR - Silent pushpad return	\$96
CD - Cylinder Dogging	N/C*
LD - Less Dogging	N/C*

*No cost when ordered with device

NOTE - Cylinders not included. Products on this page can be ordered with cylinders (C65) or Interchangeable core housings (IC7) pre-installed at Detex prior to shipping (See page 94).

NOTE - See Electrified Options for availability on devices shorter than 30", certain sizes come with EC2 endcap.



Pulls & Plates
Page 24



Lever Trims
Page 26



Electrified
Options
Page 35



00/05 SERIES NO LATCH RAIL (NO MOVING PARTS)

Device	Function	Finishes				
		630 (Std.)	628	693, 695	606, 612	605, 611, 613, 629
0000	Wide stile, no moving parts, rail with 2 endcaps	\$1,221	N/A	N/A	\$1,671	\$1,800
0500xEC2	Narrow stile, no moving parts, rail with EC2 endcaps	\$1,459	N/A	\$1,483	\$1,924	\$2,052

OPTIONS

LIST PRICE

W - Weatherized (mechanical only)	\$225
F - Fire-Rated	\$225
Custom Lengths (Specify size - min. 24", max 48")	\$160
48" - Add for 4-foot door width	\$50
SLR - Silent pushpad return	\$96
Pushpad	\$140



Pulls & Plates
Page 24



Lever Trims
Page 26

01/04 SERIES NO LATCH DUMMY BAR (ACTIVE PUSHPAD)

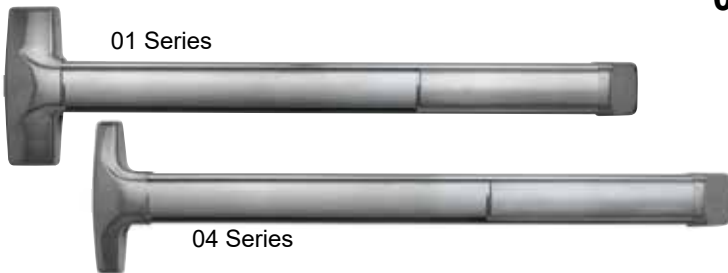

Device	Function	Finishes				
		630 (Std.)	628	693, 695	606, 612	605, 611, 613, 629
01	Active pushpad, std. head cover, no latchbolt	\$1,374	\$1,374	\$1,400	\$1,840	\$2,524
04	Active pushpad, narrow head cover, no latchbolt	\$1,553	\$1,553	\$1,581	\$2,023	\$2,701

OPTIONS

LIST PRICE

W - Weatherized (mechanical only)	\$225
Custom Lengths (Specify size - min. 24", max 48")	\$160
48" - Add for 4-foot door width	\$50
SLR - Silent pushpad return	\$96



Electrified
Options
Page 35



How To Orders

ELECTRIC UNLOCK TRIMS

	Catalog Number	Function	Lever	Device Compatibility	Finishes			
					626 (Std.)	693, 695	606, 612	605, 611, 613, 625, 629
<p>Back View 4 Posts</p>	EU*	Electric lock/ unlock	S, T, or U	10 Series 20 Series	\$1,775	\$1,789	\$1,813	\$1,843
	EUxDM*	Electric lock/ unlock	S, T, or U	30 Series	\$1,775	\$1,789	\$1,813	\$1,843
	EUV*	Electric lock/ unlock	S, T, or U	70 Series 80 Series	\$1,736	\$1,771	\$1,965	\$1,965
<p>Back View 2 Posts</p>	EU2W*	Electric lock/ unlock	S, T, or U	40 Series 50 Series	\$1,581	\$1,596	\$1,664	\$1,697

Specify Fail Secure [FSE - std.] or Fail Safe [FSA] and specify handing - **not field reversible**

* Mortise cylinder required (see page 94)

Use 625 finish for lever trim to match 629 exit device finish.

NOTE: Lever Trims are shipped RHR unless specified LHR

Also available 12VDC - Specify 12VDC

Lever Switch (LS) - Add \$325

Knurling (KN) - Add \$107

Antimicrobial (AM) - Add \$96



S Lever (Std.)











T Lever



U Lever

ELECTRONIC KEYPAD TRIM







	Catalog Number	Device Compatibility	
	TS2000-RIM	10 Series 40 Series	\$1,635
	TS2000-SVR	50 Series 51 Series	\$1,908

	Catalog Number	Function	Device Compatibility	Finishes				
				626 (Std.)	630	693, 695	606, 612	605, 611, 613, 625, 629
	01W	Exit only, cover plate	10 Series 20 Series	N/A	\$256	\$292	\$299	\$299
	01WM	Exit only, cover plate	30 Series	N/A	\$256	\$292	\$299	\$299
	03W**	Key retracts latch	10 Series 20 Series	N/A	\$256	\$292	\$320	\$348
	03WM*	Key retracts latch	30 Series	N/A	\$256	N/A	\$320	\$348
	03WS**	Key retracts latch	10 Series 20 Series	\$247	N/A	\$336	\$336	\$361
	03WSV**	Key retracts latch	70 Series 80 Series	\$397	N/A	\$486	\$486	\$511
	01C	Exit only, cover plate	10 Series 20 Series	N/A	\$317	\$398	\$398	\$398
	01CM	Exit only, cover plate	30 Series	N/A	\$317	N/A	\$398	\$398
	01CV	Exit only, cover plate	70 Series 80 Series	N/A	\$308	\$397	\$397	\$397
	02C	Dummy pull	10 Series 20 Series	N/A	\$480	\$568	\$510	\$510
	02CM	Dummy pull	30 Series	N/A	\$480	N/A	\$510	\$510
	02CV	Dummy pull	70 Series 80 Series	N/A	\$413	\$554	\$500	\$500
	03C**	Key retracts latch	10 Series 20 Series	N/A	\$498	\$697	\$585	\$585
	03CM*	Key retracts latch	30 Series	N/A	\$498	N/A	\$585	\$585
	03CV**	Key retracts latch	70 Series 80 Series	N/A	\$535	\$607	\$607	\$607
	02WP	Dummy pull (wire)	70 Series 80 Series	N/A	\$354	N/A	\$441	\$441
	02Z (Specify handing)	Dummy vandal pull	10 Series 20 Series	N/A	\$997	N/A	N/A	N/A
	03Z** (Specify handing)	Key retracts latch vandal pull	10 Series 20 Series	N/A	\$997	N/A	N/A	N/A

*Mortise cylinder required (see page 94)







Antimicrobial (AM) - Add \$96

**Rim cylinder required (see page 94)

	Catalog Number	Function	Device Compatibility	Finishes				
				626 (Std.)	630	693, 695	606, 612	605, 611, 613, 625, 629
	03WS**	Key retracts latch	40 Series 50 Series	\$247	N/A	\$252	\$336	\$361
	01CN	Exit only, cover plate	40 Series 50 Series	N/A	\$308	\$397	\$397	\$397
	01CNV	Exit only, cover plate	60 Series	N/A	\$308	\$397	\$397	\$397
	02CN	Dummy pull	40 Series 50 Series	N/A	\$467	\$568	\$511	\$511
	02CNV	Dummy pull	60 Series	N/A	\$413	\$554	\$500	\$500
	03CN**	Key retracts latch	40 Series 50 Series	N/A	\$500	\$713	\$602	\$602
	03CNV**	Key retracts latch	60 Series	N/A	\$583	\$611	\$611	\$611
	02WP	Dummy pull (wire)	60 Series	N/A	\$354	N/A	\$441	\$441
	03R**	Key retracts latch	60 Series	N/A	\$528	N/A	N/A	N/A





**Rim cylinder required (see page 94)

Antimicrobial (AM) - Add \$96

	Catalog Number	Function	Lever	Device Compatibility	Finishes			
					626 (Std.)	693, 695	606, 612	605, 611, 613, 625, 629
	01D	Blank escutcheon	N/A	10 Series 20 Series	\$698	\$753	\$786	\$843
	01DM	Blank escutcheon	N/A	30 Series	\$698	\$753	\$786	\$843
	01DV	Blank escutcheon	N/A	70 Series 80 Series	\$755	\$806	\$806	\$855
	02D	Dummy lever	S, T, or U	10 Series 20 Series	\$698	\$753	\$786	\$843
	02DM	Dummy lever	S, T, or U	30 Series	\$698	\$753	\$786	\$843
	02DV	Dummy lever	S, T, or U	70 Series 80 Series	\$755	\$806	\$806	\$855
	08D*	Key locks/unlocks lever	S, T, or U	10 Series 20 Series	\$866	\$959	\$959	\$1,011
	08DM*	Key locks/unlocks lever	S, T, or U	30 Series	\$866	\$959	\$959	\$1,011
	08DV*	Key locks/unlocks lever	S, T, or U	70 Series 80 Series	\$851	\$963	\$971	\$999
	09D*	Key unlocks lever, locked when key removed	S, T, or U	10 Series 20 Series	\$866	\$959	\$959	\$1,011
	09DM*	Key unlocks lever, locked when key removed	S, T, or U	30 Series	\$866	\$959	\$959	\$1,011
	09DV*	Key unlocks lever, locked when key removed	S, T, or U	70 Series 80 Series	\$851	\$963	\$971	\$999
	10D*	Double cylinder	S, T, or U	10 Series	\$1,167	\$1,203	\$1,309	\$1,309
	10DM*	Double cylinder	S, T, or U	30 Series	\$1,167	\$1,203	\$1,309	\$1,309
	14D	Lever always active	S, T, or U	10 Series 20 Series	\$866	\$959	\$959	\$1,011
	14DM	Lever always active	S, T, or U	30 Series	\$866	\$959	\$959	\$1,011
	14DV	Lever always active	S, T, or U	70 Series 80 Series	\$851	\$963	\$971	\$999

*Mortise cylinder required (see page 94)

Lever Switch (LS) - Add \$325
 Knurling (KN) - Add \$107
 Antimicrobial (AM) - Add \$96

	Catalog Number	Function	Lever	Device Compatibility	Finishes			
					626 (Std.)	693, 695	606, 612	605, 611, 613, 625, 629
	01DN	Blank escutcheon	N/A	40 Series 50 Series	\$644	\$718	\$753	\$811
	01DNV	Blank escutcheon	N/A	60 Series	\$785	\$791	\$791	\$951
	02DN	Dummy lever	S, T, or U	40 Series 50 Series	\$644	\$718	\$753	\$811
	02DNV	Dummy lever	S, T, or U	60 Series	\$785	\$791	\$791	\$951
	08DN*	Key locks/unlocks lever	S, T, or U	40 Series 50 Series	\$766	\$937	\$965	\$995
	08DNV*	Key locks/unlocks lever	S, T, or U	60 Series	\$916	\$951	\$1,048	\$1,068
	09DN*	Key unlocks lever, locked when key removed	S, T, or U	40 Series 50 Series	\$766	\$937	\$965	\$995
	09DNV*	Key unlocks lever, locked when key removed	S, T, or U	60 Series	\$916	\$951	\$1,048	\$1,068
	14DN	Lever always active	S, T, or U	40 Series 50 Series	\$766	\$937	\$965	\$995
	14DNV	Lever always active	S, T, or U	60 Series	\$916	\$951	\$1,048	\$1,068

*Mortise cylinder required (see page 94)

Lever Switch (LS) - Add \$325
 Knurling (KN) - Add \$107
 Antimicrobial (AM) - Add \$96



S Lever (Std.)



T Lever



U Lever



	Catalog Number	Function	Device Compatibility	630 (Std.)	Finishes			
					693, 695	606, 612	605, 611, 613, 625, 629	
	02DFSB__ †	Dummy lever	10 Series 20 Series	\$1,331	Contact factory for special pricing and extended lead times			
	02DMFSB__ †	Dummy lever	30 Series	\$1,331				
	02DVFSB__ †	Dummy lever	70 Series 80 Series	\$1,388				
	08DFSB__ *†	Key locks/unlocks lever	10 Series 20 Series	\$1,499				
	08DMFSB__ *†	Key locks/unlocks lever	30 Series	\$1,499				
	08DVFSB__ *†	Key locks/unlocks lever	70 Series 80 Series	\$1,484				
	09DFSB__ *†	Key unlocks lever, locked when key removed	10 Series 20 Series	\$1,499				
	09DMFSB__ *†	Key unlocks lever, locked when key removed	30 Series	\$1,499				
	09DVFSB__ *†	Key unlocks lever, locked when key removed	70 Series 80 Series	\$1,484				
	14DFSB__ †	Lever always active	10 Series 20 Series	\$1,499				
	14DMFSB__ †	Lever always active	30 Series	\$1,499				
	14DVFSB__ †	Lever always active	70 Series 80 Series	\$1,484				
	EUFSB__ *†	Electric lock/unlock	10 Series 20 Series	\$2,408				
	EUxDMFSB__ *†	Electric lock/unlock	30 Series	\$2,408				
	EUVFSB__ *†	Electric lock/unlock	70 Series 80 Series	\$2,369				





* Mortise cylinder required (see page 94)

NOTE: Lever Trims are shipped RHR unless specified LHR (02, 08, 09 and 14 are Field Reversible)

† To order, use FSB then 4-letter designator. (Example: FSB1076)





	Catalog Number	Function	Device Compatibility	Finishes			
				630 (Std.)	693, 695	606, 612	605, 611, 613, 625, 629
	02DNFSB__ †	Dummy lever	40 Series 50 Series	\$1,277	Contact factory for special pricing and extended lead times		
	02DNVFSB__ †	Dummy lever	60 Series	\$1,418			
	08DNFSB__ *†	Key locks/unlocks lever	40 Series 50 Series	\$1,399			
	08DNVFSB__ *†	Key locks/unlocks lever	60 Series	\$1,549			
	09DNFSB__ *†	Key unlocks lever, locked when key removed	40 Series 50 Series	\$1,399			
	09DNVFSB__ *†	Key unlocks lever, locked when key removed	60 Series	\$1,549			
	14DNFSB__ †	Lever always active	40 Series 50 Series	\$1,399			
	14DNVFSB__ †	Lever always active	60 Series	\$1,549			

* Mortise cylinder required (see page 94)

NOTE: Lever Trims are shipped RHR unless specified LHR (02, 08, 09 and 14 are Field Reversible)

† To order, use FSB then 4-letter designator. (Example: FSB1076)



1035



1016



1119



1076



1147



1093



1058



1075

BHMA Function	BHMA Definition	Description	ADVANTEX®			
			10 Series Rim	98 Series Rim	Manufacturer A Exit Devices	Manufacturer B Exit Devices
01	Exit Only	Cover Plate	01C & 01W	990EO	802-PTB	1701
02	Pull When Dogged	Dummy Pull	02C	990DT	810-PTB	1702A
02	Pull When Dogged	Dummy Vandal Pull	02Z	VR910DT	821	N/A
03	Key Retracts Latch Bolt	Night Latch Vandal Pull	03Z	VR910NL	LC-826	N/A
03	Key Retracts Latch Bolt	Night Latch Pull	03C	990NL	LC-814-PSB	1703A
03	Key Retracts Latch Bolt	Night Latch - Cylinder Only - Pull by others	03WS & 03W	110NL-OP	N/A	C03
01	Exit Only	Blank Escutcheon	01D	996EO		N/A
02	Pull When Dogged	Dummy Lever	02D	996LxDT	710-ETL	4902A
08	Key Unlocks & Locks Lever	Classroom Lever	08D	996L	LC-743-ETL	4908A
09	Lever Active by Key; Locked when key removed	Night Latch / Storeroom Lever	09D	996LxNL	LC-746-ETL	4903A
10	Inside or outside; key locks or unlocks lever	Double Cylinder Lever	10D	996L-2	LC-716-ETL	4908A
14	Lever always active	Passage Lever	14D	996LxBE	LC-715-ETL	4914A
EU	Electric Lock / Unlock	Fail Secure or Fail Safe	EU	E996L	LC-775-ETL LC-775-ETL	E4908A

BHMA Function	BHMA Definition	Description	20/21 Series SVR	9827 Series SVR	8700 Series SVR	22 Series SVR
01	Exit Only	Cover Plate	01C & 01W	990EO	802-PTB	1701
02	Pull When Dogged	Dummy Pull	02C	990DT	810-PTB	1702A
02	Pull When Dogged	Dummy Vandal Pull	02Z	VR910DT	821	N/A
03	Key Retracts Latch Bolt	Night Latch Vandal Pull	03Z	VR910NL	LC-826	N/A
03	Key Retracts Latch Bolt	Night Latch Pull	03C	990NL	N/A	1703A
03	Key Retracts Latch Bolt	Night Latch - Cylinder Only - Pull by others	03WS & 03W	370T	306	C03
01	Exit Only	Blank Escutcheon	01D	N/A	710	N/A
02	Pull When Dogged	Dummy Lever	02D	996LxDT	71-ETL	4902A
08	Key Unlocks & Locks Lever	Classroom Lever	08D	996L-2	LC-743-ETL	4908A
09	Lever Active by Key; Locked when key removed	Night Latch / Storeroom Lever	09D	996LxNL	LC-746-ETL	4903A
14	Lever always active	Passage Lever	14D	996LxBE	LC-715-ETL	4914A
EU	Electric Lock / Unlock	Fail Secure or Fail Safe	EU	E996L	773-ETL (no cylinder) 774-ETL (no cylinder)	E4908A

BHMA Function	BHMA Definition	Description	30 Series Mortise	9875 Series Mortise	8900 Series Mortise	23 Series Mortise
01	Exit Only	Cover Plate	01CM & 01WM	990EO	802-PTB	1701
02	Pull When Dogged	Dummy Pull	02CM	990DT	810-PTB	1702A
03	Key Retracts Latch Bolt	Night Latch Pull	03CM	990NL	LC-814-PTB	1703A
03	Key Retracts Latch Bolt	Night Latch - Cylinder Only - Pull by others	03WM	990NL	N/A	C03
01	Exit Only	Blank Escutcheon	01DM	N/A	710	N/A
02	Pull When Dogged	Dummy Lever	02DM	996LxDT	710-ETL	M4902A
08	Key Unlocks & Locks Lever	Classroom Lever	08DM	996L	LC-743-ETL	M4908A
09	Lever Active by Key; Locked when key removed	Night Latch / Storeroom Lever	09DM	996LxNL	LC-706-ETL (not vandal resistant)	M4903A
10	Inside or outside; key locks or unlocks lever	Double Cylinder Lever	10DM	996L-2	LC-716-ETL	M4908A
14	Lever always active	Passage Lever	14DM	996LxBE	715-ETL	M4914A
EU	Electric Lock / Unlock	Fail Secure or Fail Safe	EUxDM	E996L	LC-775-ETL LC-776-ETL	E4908A

BHMA Function	BHMA Definition	Description	ADVANTEX®	Manufacturer A Exit Devices	Manufacturer B Exit Devices	Manufacturer C Exit Devices
			40 Series Narrow Stile Rim	35A Series Narrow Stile Rim	8500 Series Narrow Stile Rim	24 Series Narrow Stile Rim
01	Exit Only	Cover Plate	01CN	360EO	N/A	2001
02	Pull When Dogged	Dummy Pull	02CN	386DT	N/A	2002A
03	Key Retracts Latch Bolt	Night Latch Pull	03CN	386NL	N/A	2003A
03	Key Retracts Latch Bolt	Night Latch - Cylinder Only - Pull by others	03WS	388	N/A	C03
01	Exit Only	Blank Escutcheon	01DN	N/A	N/A	N/A
02	Pull When Dogged	Dummy Lever	02DN	360LxDT	710-ETL	2902A
08	Key Unlocks & Locks Lever	Classroom Lever	08DN	360L	LC-743-ETL	2908A
09	Lever Active by Key; Locked when key removed	Night Latch / Storeroom Lever	09DN	360L-NL	LC-746-ETL	2903A
14	Lever always active	Passage Lever	14DN	360L-BE	715-ETL	2914A
EU	Electric Lock / Unlock	Fail Secure or Fail Safe	EU2W	E360L-BE	773-ETL (no cylinder) 774-ETL (no cylinder)	N/A

BHMA Function	BHMA Definition	Description	50/51 Series Narrow Stile SVR	3527A Series Narrow Stile SVR	Not Available	Not Available
01	Exit Only	Cover Plate	01CN	N/A	N/A	N/A
02	Pull When Dogged	Dummy Pull	02CN	386DT	N/A	N/A
03	Key Retracts Latch Bolt	Night Latch Pull	03CN	386NL	N/A	N/A
03	Key Retracts Latch Bolt	Night Latch - Cylinder Only - Pull by others	03WS	388	N/A	N/A
01	Exit Only	Blank Escutcheon	01DN	N/A	N/A	N/A
02	Pull When Dogged	Dummy Lever	02DN	360LxDT	N/A	N/A
08	Key Unlocks & Locks Lever	Classroom Lever	08DN	360L	N/A	N/A
09	Lever Active by Key; Locked when key removed	Night Latch / Storeroom Lever	09DN	360LxNL	N/A	N/A
14	Lever always active	Passage Lever	14DN	360L-BE	N/A	N/A
EU	Electric Lock / Unlock	Fail Secure or Fail Safe	EU2W	E360L-BE	N/A	N/A

BHMA Function	BHMA Definition	Description	60/61 Series Narrow Stile CVR for Aluminum Doors	3547A Series Narrow Stile CVR	AD8400 Series Narrow Stile CVR	2600 Series Narrow Stile CVR
02	Pull When Dogged	Dummy Pull (Wire)	02WP	8190	862 Pull	N/A
03	Key Retracts Latch Bolt	Night Latch - Cylinder Only - Pull by others	03R	388	100	N/A
01	Exit Only	Blank Escutcheon	01DNV	N/A	710-4	N/A
02	Pull When Dogged	Dummy Lever	02DNV	360LxDT	710-4-ETL	2902A
08	Key Unlocks & Locks Lever	Classroom Lever	08DNV	360L	LC-743-4-ETL	2908A
09	Lever Active by Key; Locked when key removed	Night Latch / Storeroom Lever	09DNV	360LxNL	LC-746-4-ETL	2903A
14	Lever always active	Passage Lever	14DNV	360L-BE	715-4-ETL	2914A

BHMA Function	BHMA Definition	Description	62/63 Series Narrow Stile CVR for Hollow Metal Doors	3547A Series Narrow Stile CVR	AD8400 Series Narrow Stile CVR	2600 Series Narrow Stile CVR
01	Exit Only	Cover Plate	01CNV	N/A	N/A	N/A
02	Pull When Dogged	Dummy Pull	02CNV	N/A	N/A	N/A
02	Pull When Dogged	Dummy Pull (Wire)	02WP	8190	862 Pull	N/A
03	Key Retracts Latch Bolt	Night Latch Pull	03CNV	388X8190	N/A	N/A
03	Key Retracts Latch Bolt	Night Latch - Cylinder Only - Pull by others	03R	388	N100	N/A
01	Exit Only	Blank Escutcheon	01DNV	N/A	710-4	N/A
02	Pull When Dogged	Dummy Lever	02DNV	N/A	710-4-ETL	N/A
08	Key Unlocks & Locks Lever	Classroom Lever	08DNV	360L	LC-743-4-ETL	2908A
09	Lever Active by Key; Locked when key removed	Night Latch / Storeroom Lever	09DNV	360L-NL	LC-746-4-ETL	2909A
14	Lever always active	Passage Lever	14DNV	360L-BE	715-4-ETL	2914A

BHMA Function	BHMA Definition	Description	ADVANTEX®			
			70/71 Series CVR for Wood Doors	Manufacturer A Exit Devices 9847 WDC Series for Wood Doors	Manufacturer B Exit Devices WD8600 Series CVR	Manufacturer C Exit Devices 2700 Series CVR for Wood Doors
01	Exit Only	Cover Plate	01CV	990EO	N/A	1701
02	Pull When Dogged	Dummy Pull	02CV	990DT	N/A	1702A
02	Pull When Dogged	Dummy Pull (Wire)	02WP	8190	862 Pull	N/A
03	Key Retracts Latch Bolt	Night Latch Pull	03CV	990NL-R/V	N/A	1703A
03	Key Retracts Latch Bolt	Night Latch - Cylinder Only - Pull by others	03WS	110NL-MD	100	N/A
01	Exit Only	Blank Escutcheon	01DV	N/A	710-4	N/A
02	Pull When Dogged	Dummy Lever	02DV	996L-DT-CV	710-4-ETL	4902A
08	Key Unlocks & Locks Lever	Classroom Lever	08DV	996L-CV	LC-743-4-ETL	4908A
09	Lever Active by Key; Locked when key removed	Night Latch / Storeroom Lever	09DV	996L-NL-CV	LC-746-4-ETL	4903A
14	Lever always active	Passage Lever	14DV	996LxBE	715-4-ETL	4914A
EU	Electric Lock / Unlock	Fail Secure or Fail Safe	EUV	E996L	773-4-ETL (no cylinder) 774-4-ETL (no cylinder)	E2703 4908A

BHMA Function	BHMA Definition	Description	ADVANTEX®			
			80/81 Series CVR for Hollow Metal Doors	9847 Series	MD8600 Series CVR	2800 Series CVR
01	Exit Only	Cover Plate	01CV	990EO	N/A	1701
02	Pull When Dogged	Dummy Pull	02CV	990DT	N/A	C1702A
02	Pull When Dogged	Dummy Pull (Wire)	02WP	8190	862 Pull	N/A
03	Key Retracts Latch Bolt	Night Latch Pull	03CV	990NL-R/V	N/A	C1703A
03	Key Retracts Latch Bolt	Night Latch - Cylinder Only - Pull by others	03WS	110NL-MD	100	N/A
01	Exit Only	Blank Escutcheon	01DV	N/A	710-4	N/A
02	Pull When Dogged	Dummy Lever	02DV	996L-DT-CV	710-4-ETL	4902A
08	Key Unlocks & Locks Lever	Classroom Lever	08DV	996L-CV	LC-743-4-ETL	4908A
09	Lever Active by Key; Locked when key removed	Night Latch / Storeroom Lever	09DV	996L-NL-CV	LC-746-4-ETL	4903A
14	Lever always active	Passage Lever	14DV	996LxBE	715-4-ETL	4914A
EU	Electric Lock / Unlock	Fail Secure or Fail Safe	EUV	E996L	773-4-ETL (no cylinder) 774-4-ETL (no cylinder)	E2803 4908A

BHMA Function	BHMA Definition	Description	ADVANTEX®			
			82/83 Series CVR for Aluminum Doors	9847 Series	AD8600 Series CVR	2800 Series CVR
01	Exit Only	Cover Plate	01CV	990EO	N/A	1701
02	Pull When Dogged	Dummy Pull	02CV	990DT	N/A	C1702A
02	Pull When Dogged	Dummy Pull (Wire)	02WP	8190	862 Pull	N/A
03	Key Retracts Latch Bolt	Night Latch Pull	03CV	990NL-R/V	N/A	C1703A
03	Key Retracts Latch Bolt	Night Latch - Cylinder Only - Pull by others	03WS	110NL-MD	100	N/A
01	Exit Only	Blank Escutcheon	01DV	N/A	710-4	N/A
02	Pull When Dogged	Dummy Lever	02DV	996L-DT-CV	710-4-ETL	4902A
08	Key Unlocks & Locks Lever	Classroom Lever	08DV	996L-CV	LC-743-4-ETL	4908A
09	Lever Active by Key; Locked when key removed	Night Latch / Storeroom Lever	09DV	996L-NL-CV	LC-746-4-ETL	4903A
14	Lever always active	Passage Lever	14DV	996LxBE	715-4-ETL	4914A
EU	Electric Lock / Unlock	Fail Secure or Fail Safe	EUV	E996L	773-4-ETL (no cylinder) 774-4-ETL (no cylinder)	E2803 4908A

BHMA Type	BHMA Definition	ADVANTEX	Manufacturer A Exit Devices	Manufacturer B Exit Devices	Manufacturer C Exit Devices
1	Rim Exit Device	10	98 99	8800	2100
	Rim Exit Device - Weatherized	10xW	No equal	No equal	No equal
2	Surface Vertical Rod Exit Device	20	9827 9927	8700	2200
	Surface Vertical Rod Exit Device - Weatherized	20xW	No equal	No equal	No equal
	Surface Vertical Rod Exit Device - Top Rod Only	21	9827-LBR 9927-LBR	NB8700	2200LBR
	Surface Vertical Rod Exit Device - Top Rod Only - Weatherized	21xW	No equal	No equal	No equal
3	Mortise Exit Device	30	9875 9975	8900	2300
4	Narrow Stile Rim Exit Device	40	33A	8400	2400
	Narrow Stile Rim Exit Device - Weatherized	40xW	No equal	No equal	No equal
5	Narrow Stile Surface Vertical Rod Exit Device	50	3327A	No equal	No equal
	Narrow Stile Surface Vertical Rod Exit Device - Weatherized	50xW	No equal	No equal	No equal
	Narrow Stile Surface Vertical Rod Exit Device - Top Rod Only	51	3327A-LBR	No equal	No equal
	Narrow Stile Surface Vertical Rod Exit Device - Top Rod Only - Weatherized	51xW	No equal	No equal	No equal
6	Narrow Stile Concealed Vertical Rod Exit Device (for Aluminum Door)	60	3347A	AD8400	2600
	Narrow Stile Concealed Vertical Rod Exit Device (for Aluminum Door) - Top Rod Only	61	3347A-LBR	NB-AD8400	2600LBR
	Narrow Stile Concealed Vertical Rod Exit Device (for Hollow Metal Door)	62	3347A	MD8400	2600
	Narrow Stile Concealed Vertical Rod Exit Device (for Hollow Metal Door) - Top Rod Only	63	3347A-LBR	NB-MD8400	2600LBR
7	Concealed Vertical Rod Exit Device (for Wood Door)	70	3347A 3547A	WD8600	2700
	Concealed Vertical Rod Exit Device (for Wood Door) - Top Rod Only	71	3347A-LBR 3547A-LBR	NB-WD8600	2700LBR
8	Concealed Vertical Rod Exit Device (for Hollow Metal Door)	80	9847 9947	MD8600	2800
	Concealed Vertical Rod Exit Device (for Hollow Metal Door) - Top Rod Only	81	9847-LBR 9947-LBR	NB-MD8600	2800LBR
	Concealed Vertical Rod Exit Device (for Aluminum Door)	82	9847 9947	AD8600	2800
	Concealed Vertical Rod Exit Device (for Aluminum Door) - Top Rod Only	83	9847-LBR 9947-LBR	NB-AD8600	2800LBR

Function	ADVANTEX [®]	Manufacturer A Exit Devices	Manufacturer B Exit Devices	Manufacturer C Exit Devices
	Standard Advantex	Standard 98 Series	Standard 80 Series	Standard 2000 Series
Hardwired Exit Alarm	EA	ALK	AL	ALW
Weatherized Battery Powered Exit Alarm	EB W	No equal	No equal	No equal
Electric Dogging	ED	No equal	58	No equal
Electric Latch Retraction	ER EX <small>Request to Exit Switch Included</small>	QEL	56	ELR
Weatherized Electric Latch Retraction	ER EX W <small>Request to Exit Switch Included</small>	No equal	No equal	No equal
Electric Lock/Unlock Lever	EU, EU2W, EUV	E996L	73/74/75/76	E
Delayed Egress	EE	CX	59	DE
Delayed Egress with Latch Retraction	EE ER	No equal	No equal	No equal
Electric Switching	ES	RXxLX	53x55	LSxTS
Latch Bolt Signaling	LX	LX	53	LS
Electric Integration	EI	No equal	No equal	No equal
Request to Exit Signaling	EX	RX	55	TS
Weatherized Request to Exit Signaling	EX W	WP-RX	No equal	WTS
Request to Exit Switching for High Current	EXV	No equal	No equal	No equal
Latch Bolt Signaling for High Current	LXV	No equal	No equal	No equal
Weatherized Request to Exit Switching for High Current	EXV W	No equal	No equal	No equal

Hardwired Exit Alarm (EA)

Price Add

Available on all non-weatherized devices

\$627

Standard Package Includes:

- Switch monitors pushpad movement and triggers alarm
- Green & Red LED, cylinder arming, 9-volt battery and piezo horn
- Manual Key Arming standard or field-selectable 2-minute auto rearm
- Remote Alarm Relay output (std) Common, Normally Open or Normally Closed Relay contacts
- Bypass Alarm Relay input (std.) Normally Open Relay Contacts
- Low Battery Alert (std), field-selectable option to remove backup battery / disable low-battery alert
- Cylinder Dogging (CD) standard or Less Dogging (LD - NOTE: Fire Rated devices come LD only)
- Self-adhesive Door Sign (EA-561 English - Red)

NOTE: EA alarm can be hardwired with 12V AC/DC through 24V AC/DC)

Options

Price Add

FC3EC1 - Flex Conduit Kit (3') includes conduit, ramped endcap and fittings	\$380
FC10EC1 - Flex Conduit Kit (10') includes conduit, ramped endcap and fittings	\$440
FC3EC2 - Flex Conduit Kit (3') includes conduit, flush endcap and fittings	\$120
FC10EC2 - Flex Conduit Kit (10') includes conduit, flush endcap and fittings	\$200
KS - Keystop feature installed	\$11
LD - Less Dogging	N/C
LX - Latch Bolt Signaling Switch (example EA LX - Available on 10/40/60/70/80 Devices)	\$314
PT-5 - Power Transfer	\$230
EWH8-626 - Electric Hinge	\$551

Accessories

PP-5152-2 Transformer 24VAC	\$127
PP-5152-3 Transformer 12VAC	\$59

Weatherized Exit Alarm (EB W) - Battery Powered

Price Add

Available on weatherized 10/20/21/40/50/51 Ddevices - *Must specify weatherized option on exit device*

\$743

Standard Package Includes:

- Remote signaling, remote bypass, pushpad monitoring
- Green & Red LED, cylinder arming, 9-volt battery and piezo horn
- Manual Key Arming standard or field-selectable 2-minute auto rearm
- Remote Alarm Relay output (std) Common, Normally Open or Normally Closed Relay contacts
- Bypass Alarm Relay input (std.) Normally Open Relay Contacts
- Low-Battery Alert (std), field-selectable option to remove backup battery / disable low-battery alert
- Cylinder Dogging (CD) standard or Less Dogging (LD - NOTE: Fire Rated devices come LD only)
- Pushpad Signage "Push to Open Alarm Will Sound"

Options

FC3EC1W - Weatherized Flex Conduit Kit (3') includes conduit, ramped endcap and fittings	\$460
FC10EC1W - Weatherized Flex Conduit Kit (10') includes conduit, ramped endcap and fittings	\$560
FC3EC2W - Weatherized Flex Conduit Kit (3') includes conduit, flush endcap and fittings	\$260
FC10EC2W - Weatherized Flex Conduit Kit (10') includes conduit, flush endcap and fittings	\$360
KS - Keystop feature installed	\$11
LD - Less Dogging	N/C

Accessories

106595-5 - Battery Eliminator 9VDC Power Source in NEMA Enclosure	\$2,225
---	---------

Electric Latch Retraction with Request to Exit Switch (ER EX)

Price Add

Available on all non-weatherized devices 30" or longer

\$1,542

Standard Package Includes:

- Simultaneous latch and quiet pushpad retraction
- Quiet latch retraction
- Long-term dogging capability
- Request to Exit Switch

(NOTE: A Power Supply Controller is required for ER EX but not included in standard package)

Options	Price Add
FC3EC1 - Flex Conduit Kit (3') includes conduit, ramped endcap and fittings	\$380
FC10EC1 - Flex Conduit Kit (10') includes conduit, ramped endcap and fittings	\$440
FC3EC2 - Flex Conduit Kit (3') includes conduit, flush endcap and fittings	\$120
FC10EC2 - Flex Conduit Kit (10') includes conduit, flush endcap and fittings	\$200
LX - Latch Bolt Signaling Switch (example EA LX - Available on 10/40/60/70/80 Devices)	\$314
PT-5 - Power Transfer	\$230
EWH8-626 - Electric Hinge	\$551

Accessories

81-800 Power Supply Controller for Latch Retraction - Single Door	See page 66
82-800 Power Supply Controller for Latch Retraction - Pairs of Doors Simultaneous	See page 66
83-800 Power Supply Controller for Latch Retraction - Pairs of Doors Independent	See page 66

Weatherized Electric Latch Retraction with Request to Exit Switch (ER EX W)

Price Add

*Available on weatherized 10/20/21/40/50/51 Devices - **Must specify weatherized option on exit device***

\$2,427

Standard Package Includes:

- Weatherized simultaneous latch and quiet pushpad retraction
- Long-term dogging capability
- Request to Exit Switch

(NOTE: A Power Supply is required for ER EX W but not included in standard package. If mounting outside, NEMA enclosure required)

Options	Price Add
FC3EC1W - Weatherized Flex Conduit Kit (3') includes conduit, ramped endcap and fittings	\$460
FC10EC1W - Weatherized Flex Conduit Kit (10') includes conduit, ramped endcap and fittings	\$560
FC3EC2W - Weatherized Flex Conduit Kit (3') includes conduit, flush endcap and fittings	\$260
FC10EC2W - Weatherized Flex Conduit Kit (10') includes conduit, flush endcap and fittings	\$360

Accessories

81-800 Power Supply Controller for Latch Retraction - Single Door	See page 66
82-800 Power Supply Controller for Latch Retraction - Pairs of Doors Simultaneous	See page 66
83-800 Power Supply Controller for Latch Retraction - Pairs of Doors Independent	See page 66

Electric Integration (EI)

Price Add

Available on non-weatherized 10/30/40 devices

\$463

Standard Package Includes:

- Switches to monitor dead latch and outside trim input
- Green and Red LED, cylinder arming and piezo horn (logic & power supply separate)
- Cylinder Dogging (CD) standard or Less Dogging (LD - NOTE: Fire Rated devices come LD only)
- Code-compliant Signage (EA-561 English Red)

(NOTE: A Logic Controller is required for EI but not included in standard package)

Options

Price Add

FC3EC1 - Flex Conduit Kit (3') includes conduit, ramped endcap and fittings	\$380
FC10EC1 - Flex Conduit Kit (10') includes conduit, ramped endcap and fittings	\$440
FC3EC2 - Flex Conduit Kit (3') includes conduit, flush endcap and fittings	\$120
FC10EC2 - Flex Conduit Kit (10') includes conduit, flush endcap and fittings	\$200
KS - Keystop feature installed	\$11
LD - Less Dogging	N/C
PT-5 - Power Transfer	\$230
EWH8-626 - Electric Hinge	\$551

Accessories

10-800 or 11-800 - Logic Controller for Electric Integration	See page 68
--	-------------

Electric Dogging (ED)

Price Add

Available on all non-weatherized devices

\$808

Standard Package Includes:

- On-board switching requires initial manual pushpad depression after electric activation
- Long-term dogging

(NOTE: A 24V power supply or logic controller is required for ED but not included.)

(NOTE: Most applications with ED require a power switch - See page 105)

Options

Price Add

FC3EC1 - Flex Conduit Kit (3') includes conduit, ramped endcap and fittings	\$380
FC10EC1 - Flex Conduit Kit (10') includes conduit, ramped endcap and fittings	\$440
FC3EC2 - Flex Conduit Kit (3') includes conduit, flush endcap and fittings	\$120
FC10EC2 - Flex Conduit Kit (10') includes conduit, flush endcap and fittings	\$200
EX - Request to Exit Switching (example ED EX)	\$284
LX - Latch Bolt Signaling Switch (example EA LX - Available on 10/40/60/70/80 Devices)	\$314
PT-5 - Power Transfer	\$230
EWH8-626 - Electric Hinge	\$551

Accessories

CS462 Keystop (For other keystop and push button options, see page 105)	\$280
PP-5152-2 24VAC transformer (Order Separately)	\$127
24V power supply for filtered, regulated power and simplified fire loop connections (Order Separately)	See page 68

Delayed Egress (EE)

Price Add

Available on all non-weatherized devices 36" or longer

\$2,703

Standard Package Includes:

- 15-second Delayed Egress - alarm switches monitor dead latch
- 15-second arming delay (AD) with extended bypass (alarm arms after door closes)
- 1-second nuisance delay
- Comes standard with 24V Filtered and Regulated Power Supply with simplified fire loop connections
- (NOTE: Detex Power Supply required and included with Standard EE package, can power devices for a pair of doors, specify 10 EE PS0 for second door)**
- Switches monitor pushpad, latch bolt and outside trim input
- Manual Key Arming standard or field-selectable 2-minute auto rearm
- Remote Alarm Relay output (std) Common, Normally Open or Normally Closed Relay contacts and Remote Reset
- Bypass Alarm Relay input (std.) Normally Open Relay Contacts
- Low-Battery Alert (std), field-selectable option to remove backup battery / disable low-battery alert
- Cylinder Dogging (CD) standard or Less Dogging (LD - NOTE: Fire Rated devices come LD only)
- Comes with one green LED, one red LED & 100 decibel alarm, field-selectable LED status indicator & self-adhesive, code-compliant door sign (ECL-395 English - 15 Second - Red)

Options	Price Add
1 - 1 Second Arming	N/C
30 - 30-Second Delayed Egress (example EE 30)	N/C
FC3EC1 - Flex Conduit Kit (3') includes conduit, ramped endcap and fittings	\$380
FC10EC1 - Flex Conduit Kit (10') includes conduit, ramped endcap and fittings	\$440
FC3EC2 - Flex Conduit Kit (3') includes conduit, flush endcap and fittings	\$120
FC10EC2 - Flex Conduit Kit (10') includes conduit, flush endcap and fittings	\$200
KS - Keystop feature installed	\$11
LD - Less Dogging	N/C
LX - Latch Bolt Signaling Switch (example EA LX - Available on 10/40/60/70/80 Devices)	\$314
SA - Silent Arming	\$242
PT-5 - Power Transfer	\$230
EWH8-626 - Electric Hinge	\$551
L9 - Less Battery	\$11
SI - Status Indicator	\$9
L9xSI - Less Battery & Status Indicator	\$20
PS0 - Less Power Supply	Subtract \$225

Delayed Egress With External Logic (EEX)

Price Add

Available on non-weatherized 10/20/30/40/50 devices 36" and longer

\$1,797

Standard Package Includes:

- Hex dogging (CD & LD available)
- Fire and hurricane rated available
- Includes delay egress 15 second door sign
- (NOTE: A Logic Controller is required but not included in standard package)**

Options	Price Add
12-800 Logic Controller	See page 68

Delayed Egress With External Logic for Outdoor Use (EEX W)

Price Add

Available on weatherized 10/20/40/50 devices 36" and longer - *Must specify weatherized option on exit device*

\$1,797

Standard Package Includes:

- Hex dogging (CD & LD available)
- Fire and hurricane rated available
- Includes delay egress 15 second door sign
- (NOTE: A Logic Controller is required but not included in standard package)**

Options	Price Add
106595-1 Logic Controller in NEMA enclosure for use outdoors	See page 68

Delayed Egress with Latch Retraction (EE ER EX)

Price Add

Available on all non-weatherized devices 36" or longer

\$3,806

Standard Package Includes:

- Switches to monitor pushpad and dead latch
- Quiet latch retraction
- Request to Exit Switch
- Sold separately, but required and Included as part of Power Supply Controller is the Remote, wall-mount keyswitch & horn, with green and red LED, 100-dB alarm (RIU) as part of 84-800 and 85-800

(NOTE: A Logic Controller is required for EE ER but not included in standard package)

For options such as Silent Arming, arming times, set grant times, Keystop (armed when key removed) Rearm using Key Only, access control only bypasses (RKO) and other options, see power supply controllers on pages 66-67.

Options

Price Add

30 - 30-Second Delayed Egress (example EE ER 30) (NOTE: determined by power supply - See below)	N/C
FC3EC1 - Flex Conduit Kit (3') includes conduit, ramped endcap and fittings	\$380
FC10EC1 - Flex Conduit Kit (10') includes conduit, ramped endcap and fittings	\$440
FC3EC2 - Flex Conduit Kit (3') includes conduit, flush endcap and fittings	\$120
FC10EC2 - Flex Conduit Kit (10') includes conduit, flush endcap and fittings	\$200
KS - Keystop feature installed	\$11
LX - Latch Bolt Signaling Switch (example EA LX - Available on 10/40/60/70/80 Devices)	\$314
PT-5 - Power Transfer	\$230
EWH8-626 - Electric Hinge	\$551

Accessories

84-800 Power Supply Controller for single doors - for options such as Silent Arming / no chirps (SA), Reset with Key Only, access control does not reset alarm, just bypass (RKO), contact factory – includes wall-mount key switch & Horn interface box (RIU)	See page 67
85-800 Power Supply Controller for pairs of doors - for options such as Silent Arming / no chirps (SA), Reset with Key Only, access control does not reset alarm, just bypass (RKO), contact factory – includes wall-mount key switch & Horn interface box (RIU)	See page 67

Electric Switching (ES)

Price Add

Available on non-weatherized 10/30/40 devices

\$395

Standard Package Includes:

- Switches to monitor dead latch and outside trim input
- Hex Dogging (HD) standard or Less Dogging (LD - NOTE: Fire Rated devices come LD only)

(NOTE: A Logic Controller is required for EI but not included in standard package)

Options

FC3EC1 - Flex Conduit Kit (3') includes conduit, ramped endcap and fittings	\$380
FC10EC1 - Flex Conduit Kit (10') includes conduit, ramped endcap and fittings	\$440
FC3EC2 - Flex Conduit Kit (3') includes conduit, flush endcap and fittings	\$120
FC10EC2 - Flex Conduit Kit (10') includes conduit, flush endcap and fittings	\$200
CD - Cylinder Dogging	N/C
LD - Less Dogging	N/C
PT-5 - Power Transfer	\$230
EWH8-626 - Electric Hinge	\$551

Request to Exit Signaling (EX)

Price Add

Available on all non-weatherized devices

\$284

Standard Package Includes:

- Request to Exit Signal Switch provides 3 wires for either normally open or normally closed signaling when pushpad is pressed
- Hex Dogging (HD) standard or Less Dogging (LD - NOTE: Fire Rated devices come LD only)

Options	Price Add
FC3EC1 - Flex Conduit Kit (3') includes conduit, ramped endcap and fittings	\$380
FC10EC1 - Flex Conduit Kit (10') includes conduit, ramped endcap and fittings	\$440
FC3EC2 - Flex Conduit Kit (3') includes conduit, flush endcap and fittings	\$120
FC10EC2 - Flex Conduit Kit (10') includes conduit, flush endcap and fittings	\$200
CD - Cylinder Dogging	N/C
LD - Less Dogging	N/C
LX - Latch Bolt Signaling Switch (example EX LX - Available on 10/40/60/70/80 Devices)	\$314
PT-5 - Power Transfer	\$230
EWH8-626 - Electric Hinge	\$551

Weatherized Request to Exit Signaling (EX W)

Price Add

*Available on weatherized 10/20/21/40/50/51/01/04 devices - **Must specify weatherized option on exit device***

\$162

Standard Package Includes:

- Weatherized Request to Exit Signal Switch provides 3 wires for either normally open or normally closed signaling when pushpad is pressed
- Hex Dogging (HD) standard or Less Dogging (LD - NOTE: Fire Rated devices come LD only)

Options	Price Add
FC3EC1W - Weatherized Flex Conduit Kit (3') includes conduit, ramped endcap and fittings	\$460
FC10EC1W - Weatherized Flex Conduit Kit (10') includes conduit, ramped endcap and fittings	\$560
FC3EC2W - Weatherized Flex Conduit Kit (3') includes conduit, flush endcap and fittings	\$260
FC10EC2W - Weatherized Flex Conduit Kit (10') includes conduit, flush endcap and fittings	\$360
CD - Cylinder Dogging	N/C
LD - Less Dogging	N/C

Latch Bolt Signaling (LX)

Price Add

Available on non-weatherized 10/40/60/61/62/63/70/71/80/81/82/83 devices

\$314

Standard Package Includes:

- Switch monitors latchbolt
- Hex Dogging (HD) standard or Less Dogging (LD - NOTE: Fire Rated devices come LD only)

Options	Price Add
FC3EC1 - Flex Conduit Kit (3') includes conduit, ramped endcap and fittings	\$380
FC10EC1 - Flex Conduit Kit (10') includes conduit, ramped endcap and fittings	\$440
FC3EC2 - Flex Conduit Kit (3') includes conduit, flush endcap and fittings	\$120
FC10EC2 - Flex Conduit Kit (10') includes conduit, flush endcap and fittings	\$200
CD - Cylinder Dogging	N/C
LD - Less Dogging	N/C
PT-5 - Power Transfer	\$230
EWH8-626 - Electric Hinge	\$551

Accessories	Price Add
MS-1039S/1059S - Magnetic Switch (Surface)	\$96
MS-1039F/1059F - Magnetic Switch (Flush)	\$55

Latch Bolt Signaling for High Current (LXV)

Price Add

Available on non-weatherized 10/40/60/61/62/63/70/71/80/81/82/83 devices

\$493

Standard Package Includes:

- 3-Amp switch monitors latchbolt
- Hex Dogging (HD) standard or Less Dogging (LD - NOTE: Fire Rated devices come LD only)

Options

Price Add

FC3EC1 - Flex Conduit Kit (3') includes conduit, ramped endcap and fittings	\$380
FC10EC1 - Flex Conduit Kit (10') includes conduit, ramped endcap and fittings	\$440
FC3EC2 - Flex Conduit Kit (3') includes conduit, flush endcap and fittings	\$120
FC10EC2 - Flex Conduit Kit (10') includes conduit, flush endcap and fittings	\$200
CD - Cylinder Dogging	N/C
LD - Less Dogging	N/C
PT-5 - Power Transfer	\$230
EWH8-626 - Electric Hinge	\$551

Accessories

MS-1039S/1059S - Magnetic Switch (Surface)	\$96
MS-1039F/1059F - Magnetic Switch (Flush)	\$55

Request to Exit Signaling for High Current (EXV)

Price Add

Available on all non-weatherized devices

\$430

Standard Package Includes:

- 3-Amp Switch monitors pushpad
- Hex Dogging (HD) standard or Less Dogging (LD - NOTE: Fire Rated devices come LD only)

Options

Price Add

FC3EC1 - Flex Conduit Kit (3') includes conduit, ramped endcap and fittings	\$380
FC10EC1 - Flex Conduit Kit (10') includes conduit, ramped endcap and fittings	\$440
FC3EC2 - Flex Conduit Kit (3') includes conduit, flush endcap and fittings	\$120
FC10EC2 - Flex Conduit Kit (10') includes conduit, flush endcap and fittings	\$200
CD - Cylinder Dogging	N/C
LD - Less Dogging	N/C
LX - Latch Bolt Signaling Switch (example EX LX - Available on 10/40/60/70/80 Devices)	\$314
2 - Includes 2 High-Current Switches (EXV2)	\$428
PT-5 - Power Transfer	\$230
EWH8-626 - Electric Hinge	\$551

Weatherized Request to Exit Signaling for High Current (EXV W)

Price Add

Available on weatherized 10/20/21/40/50/51/01/04 Devices - *Must specify weatherized option on exit device*

\$357

Standard Package Includes:

- 3-Amp Weatherized switch monitors pushpad
- Hex Dogging (HD) standard or Less Dogging (LD - NOTE: Fire Rated devices come LD only)

Options

Price Add

FC3EC1W - Weatherized Flex Conduit Kit (3') includes conduit, ramped endcap and fittings	\$275
FC10EC1W - Weatherized Flex Conduit Kit (10') includes conduit, ramped endcap and fittings	\$294
FC3EC2W - Weatherized Flex Conduit Kit (3') includes conduit, flush endcap and fittings	\$148
FC10EC2W - Weatherized Flex Conduit Kit (10') includes conduit, flush endcap and fittings	\$213
CD - Cylinder Dogging	N/C
LD - Less Dogging	N/C

SIF-EA - Electric Slide-In Filler Kit		Finishes:	628, 630, 693, 695	606, 612	605, 611, 613, 629	
SIF-EA	Exit Alarm 9VDC/12VAC with remote signal and remote bypass	36" Device	\$631	\$724	\$790	
		48" Device	\$653	\$766	\$812	
Kit Includes: Endcap Bracket with Battery Clip, 9V Battery, Warning Sign (ECL-561)						
NOTE: YOU MUST SPECIFY THE DEVICE SERIES, DOGGING, STILE, STRIKE, SIZE, ENDCAP AND FINISH WHEN ORDERING.						
Options						
KS	Keystop Kit				\$11	
SIF-EB-W - Weatherized Battery Powered Exit Alarm Slide-In Filler Kit		Finishes:	630	606, 612	605, 611, 613, 629	
SIF-EB-W	Weatherized Battery Powered Exit Alarm with remote signal and remote bypass	36" Device	\$982	\$1,075	\$1,141	
		48" Device	\$1,004	\$1,097	\$1,163	
Kit Includes: Endcap Bracket with Battery Clip, 9V Battery, Warning Sign (ECL-561)						
NOTE: YOU MUST SPECIFY THE DEVICE SERIES, DOGGING, STILE, STRIKE, SIZE, ENDCAP AND FINISH WHEN ORDERING.						
Options						
KS	Keystop Kit				\$11	
SIF-HD-CD-LD Slide-In Filler Kits		Finishes:	628, 630, 693, 695	606, 612	605, 611, 613, 629	
SIF-LD-36	Less Dogging Slide-In Filler	36" Device	\$199	\$292	\$358	
SIF-LD-48	Less Dogging Slide-In Filler	48" Device	\$221	\$314	\$380	
SIF-HD-36	Hex Key Dogging Slide-In Filler	36" Device	\$250	\$343	\$409	
SIF-HD-48	Hex Key Dogging Slide-In Filler	48" Device	\$272	\$365	\$431	
SIF-CD-36	Cylinder Dogging Slide-In Filler	36" Device	\$250	\$343	\$409	
SIF-CD-48	Cylinder Dogging Slide-In Filler	48" Device	\$272	\$365	\$431	
NOTE: YOU MUST SPECIFY THE DEVICE SERIES, DOGGING, STILE, STRIKE, SIZE, ENDCAP (EC1/EC2) AND FINISH WHEN ORDERING.						
Strikes			Finishes:	630	606, 612	605, 611, 613, 629
90	Non-Handed Curved Lip Strike (for 30 Series Devices)			\$56	\$83	\$228
91	ANSI Flat Lip Strike (for 30 Series Devices)			\$56	\$83	\$228
92	Double Door Short Open Back Strike (for 30 Series Devices)			\$347	\$228	\$228
93	Double Door Long Open Back Strike (for 30 Series Devices)			\$447	\$228	\$228
94	Double Door Strike Kit with Tamper-Resistant and Standard Fasteners (No security driver required)					\$96
95T	Top Strike (for 60/61/62/63/70/71/80/81/82/83 Series Devices)					\$120
95B	Bottom Strike (for 60/62/70/80/82 Series Devices)					\$50
96 Top	Surface Non-Roller Strike (for 50/51 Series Devices)					\$50
96B Bottom	Dustproof Strike (for 50 Series Devices)					\$70
97 Top	Surface Non-Roller Strike (for 20/21 Series Devices)					\$50
97 Bottom	Dustproof Strike (for 20 Series Devices)					\$70
98	Semi-Mortise Strike (for 10/40 Series Devices) - Contact factory					\$70
99	Surface Non-Roller Strike (for 10/40 Series Devices)					\$58
99R	Roller Strike (for 5 Foot Exit Device Only)					\$479
995T	Top Strike Kit FEMA (for 87 Series Device only)					\$605
SHK1	Strike Hook Kit (1 per package)					\$29

Hex Dogging Key					Price
HDK	Hex Dogging Key				\$11
Surface Vertical Rod Conversion Kit		Finishes:	630, 693, 695	606, 612	605, 611, 613, 629
SVRK-8-X	Converts 7-foot rods to 8-foot rods		\$400	\$500	\$600
SVRK-10-X	Converts 7-foot rods to 10-foot rods		\$700	\$800	\$900
Sex Nuts - Security Screws - Security Bits					Price
SN1	Sex Nut Kit - 1/4"-20 (2 per package) - Specify Finishes: 606, 613, 630				\$29
SSK1	Torx® Security Screw Kit for Rim Exit Device, Stainless Steel only, incl. Torx® bits				\$64
SSK2	Torx® Security Screw Kit for SVR Exit Device, Stainless Steel only, incl. Torx® bits				\$79
TT10	Torx® driver tip for 6-32 undercut FH screws				\$17
TT15	Torx® driver tip for 6-32 FH screws				\$17
TT25	Torx® driver tip for 10-32 FH screws				\$17
TT27	Torx® driver tip for 1/4" and #14 screws				\$17
Glass Bead Kits					Price
GB1	Glass Bead Kit - 10 Series/70 Series/80 Series				\$111
GB2	Glass Bead Kit - 40 Series/60 Series w/ EC2 endcap				\$111
GB3	Glass Bead Kit - 20 Series (7-foot height)				\$489
GB4	Glass Bead Kit - 21 Series (7-foot height)				\$268
GB5	Glass Bead Kit - 50 Series (7-foot height)				\$489
GB6	Glass Bead Kit - 51 Series (7-foot height)				\$268
GB7	Glass Bead Kit - 20 Series (8-foot height)				\$581
GB8	Glass Bead Kit - 21 Series (8-foot height)				\$423
GB9	Glass Bead Kit - 50 Series (8-foot height)				\$581
GB10	Glass Bead Kit - 51 Series (8-foot height)				\$423
GB11	Glass Bead Kit - 20 Series (10-foot height)				\$612
GB12	Glass Bead Kit - 21 Series (10-foot height)				\$455
GB13	Glass Bead Kit - 50 Series (10-foot height)				\$651
GB14	Glass Bead Kit - 51 Series (10-foot height)				\$455
GB16	Glass Bead Kit - 30 Series				\$111
Shaft Extension Kits					Price
SE-2	Shaft Extension Kit for Lever Trims for 2 - 2-1/2" thick door				\$91
SE-25	Shaft Extension Kit for Lever Trims for 2-1/8 - 2-3/4" thick door				\$91
SE-3	Shaft Extension Kit for Lever Trims for 2-5/8 - 3-1/4" thick door				\$142
SE-35	Shaft Extension Kit for Lever Trims for 3-1/8 - 3-3/4" thick door				\$142
SE-4	Shaft Extension Kit for Lever Trims for 3-5/8 - 4-1/4" thick door				\$142
SE-65	Shaft Extension Kit for Lever Trims for 6 - 6-5/8" thick door				\$142
Throughbolt Mounting Plates					Price
TMP1	Throughbolt Mounting Plate (Top only SVR Kit)				\$57
TMP2	Throughbolt Mounting Plate (Top and bottom SVR Kit)				\$81
Endcaps		Finish:	630	605, 606, 611, 612, 613, 629, 693, 695	
EC1	Ramped Endcap Heavy Duty		\$120		\$236
EC2	Flush Endcap		\$112		\$173
EC2FC	Flush Endcap with Flex Conduit Fitting		\$152		\$152

Flex Conduit Kits, Armored Loops and Power Transfers		Finishes:	605, 606, 611, 612, 613, 629, 630, 693, 695
FC3EC1-630	Flex Conduit Kit (3') includes conduit, ramped endcap and fittings		\$380
FC10EC1-630	Flex Conduit Kit (10') includes conduit, ramped endcap and fittings		\$440
FC3EC2-630	Flex Conduit Kit (3') includes conduit, flush endcap and fittings		\$120
FC10EC2-630	Flex Conduit Kit (10') includes conduit, flush endcap and fittings		\$200
FC3EC1W-630	Weatherized Flex Conduit Kit (3') includes conduit, ramped endcap and fittings		\$460
FC10EC1W-630	Weatherized Flex Conduit Kit (10') includes conduit, ramped endcap and fittings		\$560
FC3EC2W-630	Weatherized Flex Conduit Kit (3') includes conduit, flush endcap and fittings		\$260
FC10EC2W-630	Weatherized Flex Conduit Kit (10') includes conduit, flush endcap and fittings		\$360
AL18	Surface Mount Armor Loop - 18" (Aluminum Finish)		\$184
JB-R	Junction Box with Relay		\$518
PT-5	Power Transfer		\$230
EWH8-626	Electric Hinge		\$551
Delayed Egress Peel & Stick Door Signage Chart			Price
PUSH UNTIL ALARM SOUNDS - DOOR CAN BE OPENED IN XX SECONDS			
ECL-395	English - 15 Second - Red (Std.)		\$23
ECL-395-1	English - 30 Second - Red		\$23
ECL-395-2	French/Canadian - 15 Second - Red		\$23
ECL-395-3	French/Canadian - 30 Second - Red		\$23
ECL-395-4	Spanish - 15 Second - Red		\$23
ECL-395-5	Spanish - 30 Second - Red		\$23
ECL-395-6	French - 15 Second - Green		\$23
ECL-395-7	French - 30 Second - Green		\$23
ECL-395-8	German - 15 Second - Green		\$23
ECL-395-9	German - 30 Second - Green		\$23
ECL-395-10	Chinese - 15 Second - Red		\$23
ECL-395-11	Chinese - 30 Second - Red		\$23
ECL-395-12	English European - 15 Second - Green		\$23
ECL-395-13	English European - 30 Second - Green		\$23
Peel & Stick Door Sign			Price
PUSH TO OPEN - ALARM WILL SOUND			
101802-1	English - Green		\$26
101802-2	French - Green		\$26
101802-3	German - Green		\$26
101802-4	Chinese - Red		\$26
101802-5	Spanish - Red		\$26
101802-6	French/Canadian - Red		\$26
Delayed Egress Outdoor Signage Chart			Price
PUSH UNTIL ALARM SOUNDS - DOOR CAN BE OPENED IN 15/30 SECONDS			
101906	English - 15 Second (Metal Sign - Non-Adhesive)		\$128
101906-1	English - 30 Second (Metal Sign - Non-Adhesive)		\$128

MODEL NO.	DESCRIPTION	PRICE
GTPLKIT	Gate Plate Kit - Includes Gate Latch Protector (GTPLGRD), Strike Latch Receiver Bracket (GTSTKBKT), Adjustable Gate Plate (GTPL)	\$1,245
GTPLKIT-5	Gate Plate Kit for 60" Wide Gates - Includes Gate Latch Protector (GTPLGRD), Strike Latch Receiver Bracket (GTSTKBKT), Adjustable Gate Plate (GTPL-5)	\$1,960

MODEL NO.	DESCRIPTION	PRICE
GTPL	Adjustable Gate Plate - Fits Single Gates 32" - 52" wide Fits square or round gate frames Plate comes without mounting holes for device	\$901
GTPL-5	Adjustable Gate Plate - Fits Single Gates 60" wide Fits square or round gate frames Plate comes without mounting holes for device	\$1,616
GTSTKBKT	Strike Latch Receiver Bracket	\$361
GTPLGRD	Gate Latch Protector	\$190
03GS	Optional 03 function cylinder trim used on gates (Rim Cylinder sold separately)	\$184
08GS	Spacer for Wide Lever Trim	\$197
08GSN	Spacer for Narrow Lever Trim	\$197

All above parts available in black (specify -BLK - ex. GTPL-BLK) and gray (std.) finish
For rim applications (further fabrication to opening required for SVR applications)

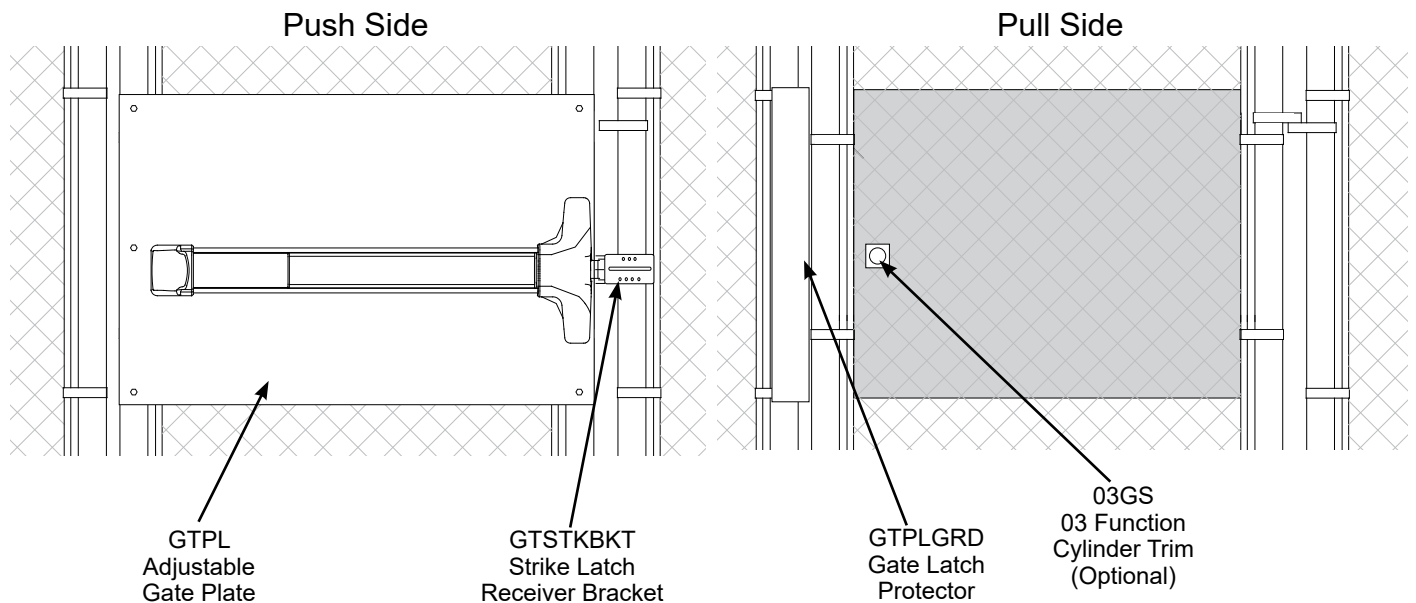

EXIT DEVICE SOLD SEPARATELY

For more information, see Advantex weatherized exit devices

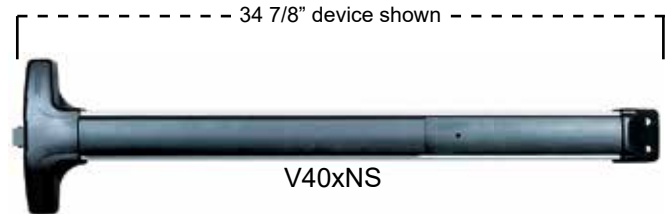
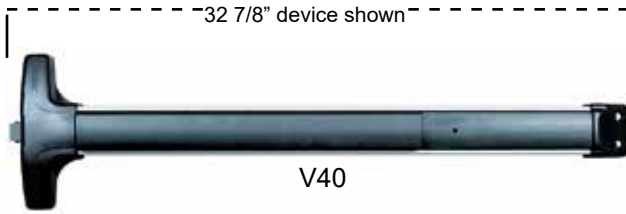

Finishes

Device	628 (Std.)	711
V40	\$626	\$626
V40xNS	\$690	\$690

To order trim with exit device, specify exit device followed by trim (ex. V4002BN, V4002BNxNS). See pages 49-53 for trims.

V40 DEVICE COMES STANDARD WITH

- * 628 Aluminum Baseplate
- * Hex Dogging
- * 36" Device for 3-foot doors
- * 99 Surface Strike

V40xNS DEVICE COMES STANDARD WITH

- * 628 Aluminum Baseplate
- * Hex Dogging
- * 36" Device for 3-foot doors
- * 98 Semi-Mortise Strike
- * Extended extrusion

OPTIONS

LIST PRICE

F - Fire-Rated	\$225
H - Hurricane Rated (V40 only)	\$125
FH - Fire-Rated / Hurricane Rated (V40 only)	\$350
W - Weatherized	\$225
48" - Add for 4-foot door width	\$50
SN1 - Sex Nuts / Throughbolts -Device with trim requires 1 set -Device only requires 2 sets	\$29/set
KS - Keystop installed (alarm always armed when key removed)	\$11
CD - Cylinder Dogging	N/C*
LD - Less Dogging	N/C*
94 - Double Door Strike (V40 only)	N/C*
98 - Semi-Mortise Strike (V40 only)	N/C*

*No cost when ordered with device

NOTE - Cylinders not included. Products on this page can be ordered with cylinders (C65) or Interchangeable core housings (IC7) pre-installed at Detex prior to shipping (See page 94).



How To Orders



Pulls & Plates
Page 50



Lever Trims
Page 52



Electrified
Options
Page 56

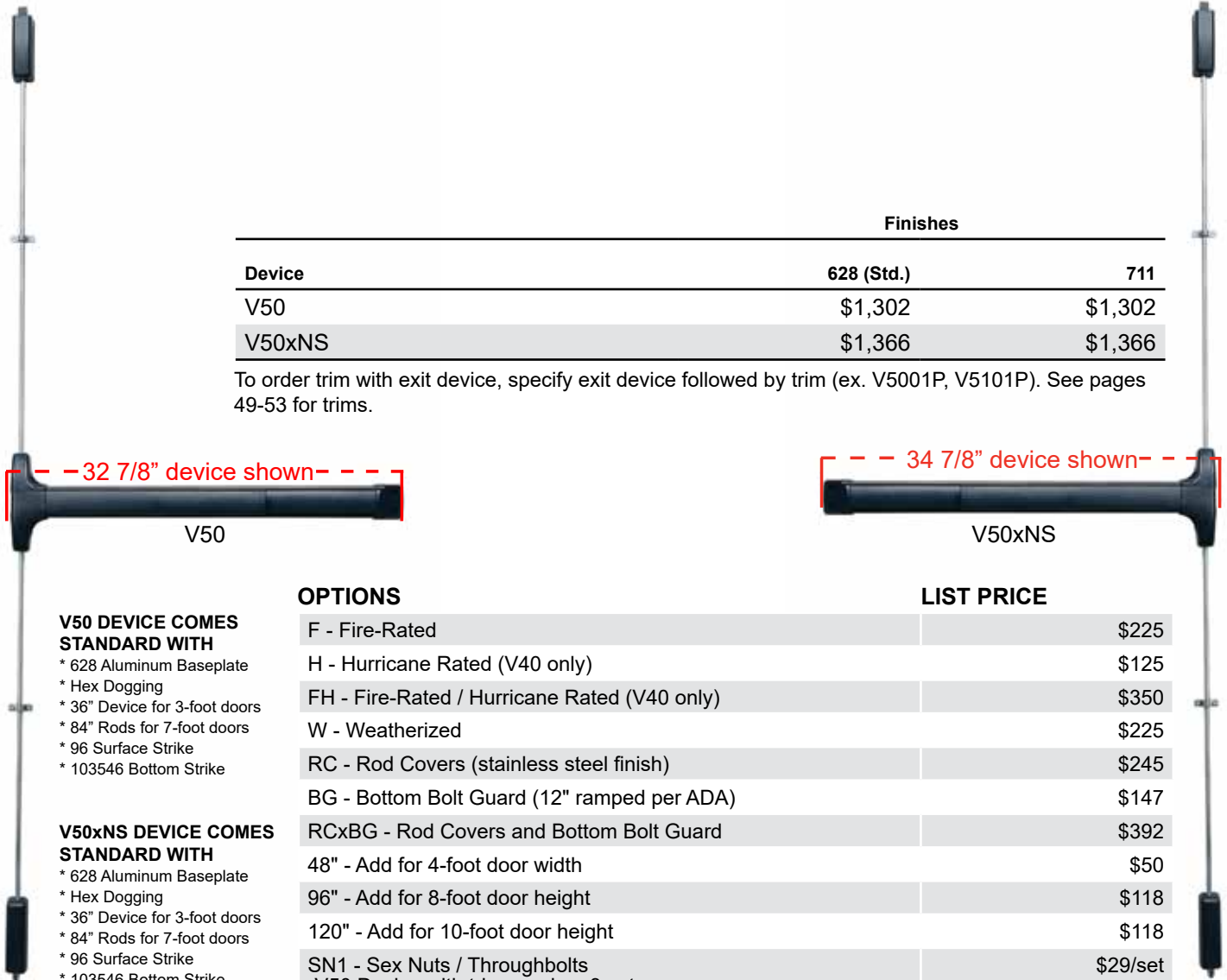

Finishes		
Device	628 (Std.)	711
V50	\$1,302	\$1,302
V50xNS	\$1,366	\$1,366

To order trim with exit device, specify exit device followed by trim (ex. V5001P, V5101P). See pages 49-53 for trims.

V50 DEVICE COMES STANDARD WITH

- * 628 Aluminum Baseplate
- * Hex Dogging
- * 36" Device for 3-foot doors
- * 84" Rods for 7-foot doors
- * 96 Surface Strike
- * 103546 Bottom Strike

V50xNS DEVICE COMES STANDARD WITH

- * 628 Aluminum Baseplate
- * Hex Dogging
- * 36" Device for 3-foot doors
- * 84" Rods for 7-foot doors
- * 96 Surface Strike
- * 103546 Bottom Strike
- * Extended extrusion

OPTIONS

LIST PRICE

F - Fire-Rated	\$225
H - Hurricane Rated (V40 only)	\$125
FH - Fire-Rated / Hurricane Rated (V40 only)	\$350
W - Weatherized	\$225
RC - Rod Covers (stainless steel finish)	\$245
BG - Bottom Bolt Guard (12" ramped per ADA)	\$147
RCxBG - Rod Covers and Bottom Bolt Guard	\$392
48" - Add for 4-foot door width	\$50
96" - Add for 8-foot door height	\$118
120" - Add for 10-foot door height	\$118
SN1 - Sex Nuts / Throughbolts -V50 Device with trim requires 3 sets -V50 Device only requires 4 sets -V50xNS Device with trim requires 3 sets -V50xNS Device only requires 4 sets	\$29/set
KS - Keystop installed (alarm always armed when key removed)	\$11
CD - Cylinder Dogging	N/C*
LD - Less Dogging	N/C*
96B - Dustproof Strike	\$70



How To Orders

*No cost when ordered with device

NOTE - Cylinders not included. Products on this page can be ordered with cylinders (C65) or Interchangeable core housings (IC7) pre-installed at Detex prior to shipping (See page 94).



Pulls & Plates
Page 50



Lever Trims
Page 52



Electrified
Options
Page 56

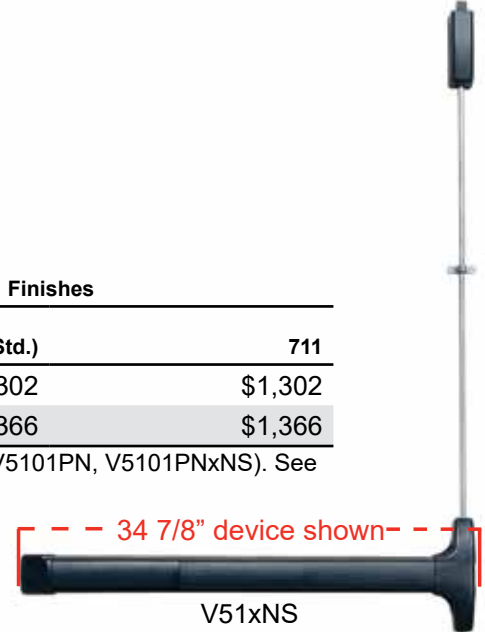
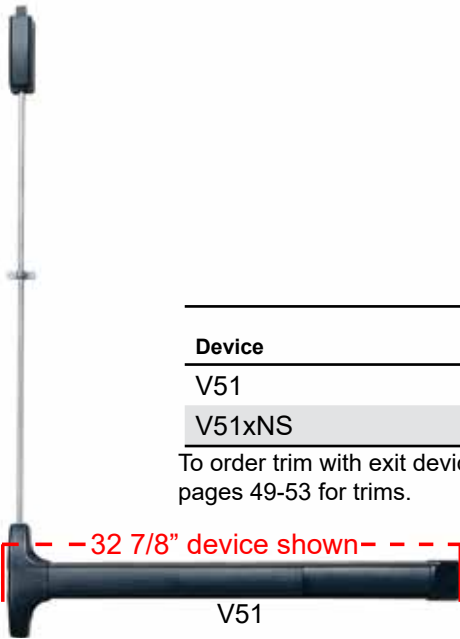

Device	Finishes	
	628 (Std.)	711
V51	\$1,302	\$1,302
V51xNS	\$1,366	\$1,366

To order trim with exit device, specify exit device followed by trim (ex. V5101PN, V5101PNxNS). See pages 49-53 for trims.

V51 DEVICE COMES STANDARD WITH

- * 628 Aluminum Baseplate
- * Hex Dogging
- * 36" Device for 3-foot doors
- * 84" Rods for 7-foot doors
- * 96 Surface Strike

V51xNS DEVICE COMES STANDARD WITH

- * 628 Aluminum Baseplate
- * Hex Dogging
- * 36" Device for 3-foot doors
- * 84" Rods for 7-foot doors
- * 96 Surface Strike
- * Extended extrusion



How To Orders

OPTIONS

LIST PRICE

F - Fire-Rated	\$225
H - Hurricane Rated (V40 only)	\$125
FH - Fire-Rated / Hurricane Rated (V40 only)	\$350
W - Weatherized	\$225
RC - Rod Covers (stainless steel finish)	\$245
48" - Add for 4-foot door width	\$50
96" - Add for 8-foot door height	\$118
120" - Add for 10-foot door height	\$118
SN1 - Sex Nuts / Throughbolts	\$29/set
-V51 Device with trim requires 2 sets	
-V51 Device only requires 3 sets	
-V51xNS Device with trim requires 2 sets	
-V51xNS Device only requires 3 sets	
KS - Keystop installed (alarm always armed when key removed)	\$11
CD - Cylinder Dogging	N/C*
LD - Less Dogging	N/C*

*No cost when ordered with device

NOTE - Cylinders not included. Products on this page can be ordered with cylinders (C65) or Interchangeable core housings (IC7) pre-installed at Detex prior to shipping (See page 94).



Pulls & Plates
Page 50



Lever Trims
Page 52



Electrified
Options
Page 56



How To Orders

ELECTRIC UNLOCK LEVER TRIM

	Catalog Number	Function	Lever	Device Compatibility	Finishes	
					626	693
	EU2W*	Electric lock/ unlock	S	V40 Series V50/V51 Series	\$1,581	\$1,596

Specify Fail Secure [FSE - std.] or Fail Safe [FSA] and specify handing - **not field reversible**)

* Mortise cylinder required (see page 94)

NOTE: Lever Trims are shipped RHR unless specified LHR

Also available 12VDC - Specify 12VDC

LS Lever Switch available - Add \$325







S Lever (Std.)

ELECTRONIC KEYPAD TRIM





	Catalog Number	Device Compatibility	
		TS2000-RIM	V40 Series
TS2000-SVR		V50 Series V51 Series	\$1,908

	Catalog Number	Function	Finishes							
			Gray				Brown	Black		
			626	628	630	689	695	693	711	
	01P	Cover plate	N/A	\$142	N/A	N/A	N/A	N/A	N/A	\$142
	03P**	Key retracts latch	N/A	\$142	N/A	N/A	N/A	N/A	N/A	\$142
	02WP	Dummy pull (wire)	N/A	N/A	\$354	N/A	N/A	N/A	N/A	N/A
	03WS**	Key retracts latch	\$247	N/A	N/A	N/A	N/A	N/A	\$336	N/A
	02A	Dummy pull	N/A	N/A	N/A	\$155	\$155	\$155	\$155	N/A
	03A**	Key retracts latch	N/A	N/A	N/A	\$155	\$155	\$155	\$155	N/A

**Rim cylinder required (see page 94)

	Catalog Number	Function	Finishes					
			Gray			Brown	Black	
			628	630	689	695	693	711
	01PN	Cover plate	\$142	N/A	N/A	N/A	N/A	\$142
	03PN**	Key retracts latch	\$142	N/A	N/A	N/A	N/A	\$142
	03CN**	Key retracts latch	N/A	\$500	N/A	\$713	\$713	N/A
	02AN	Dummy pull	N/A	N/A	\$155	\$155	\$155	N/A
	03AN**	Key retracts latch	N/A	N/A	\$155	\$155	\$155	N/A

**Rim cylinder required (see page 94)

	Catalog Number	Function	Lever	Device Compatibility	Finishes	
					689	693
	02BN	Dummy lever	S	V40 V40xNS V50/V51 V50xNS/V51xNS	\$439	\$439
	08BN*	Key locks/unlocks outside lever	S	V40 V40xNS V50/V51 V50xNS/V51xNS	\$439	\$439
	09BN*	Lever trim active by key, locked when key removed	S	V40 V40xNS V50/V51 V50xNS/V51xNS	\$439	\$439
	14BN	Outside lever always active	S	V40 V40xNS V50/V51 V50xNS/V51xNS	\$439	\$439





* Mortise cylinder required (see page 94)

Lever Switch (LS) - Add \$325



S Lever (Std.)

VANDAL RESISTANT TRIMS

	Catalog Number	Function	Lever	Device Compatibility	Finishes	
					626	693
	02D2W	Dummy lever	S	V40 Series V50/V51 Series	\$633	\$689
	08D2W*	Key locks/unlocks outside lever	S	V40 Series V50/V51 Series	\$755	\$811
	09D2W*	Lever trim active by key, locked when key removed	S	V40 Series V50/V51 Series	\$755	\$811
	14D2W	Outside lever always active	S	V40 Series V50/V51 Series	\$755	\$811

* Mortise cylinder required (see page 94)

Lever Switch (LS) - Add \$325



S Lever (Std.)

Back View

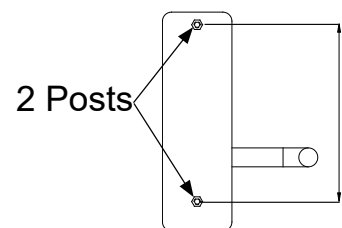

BHMA Function	BHMA Definition	VALUE SERIES®	Manufacturer A Exit Devices	Manufacturer B Exit Devices	Manufacturer C Exit Devices
1	Rim Exit Device	V40	22	2828	5100
	Rim Exit Device - Weatherized	V40xW	No equal	No equal	No equal
2	Surface Vertical Rod Exit Device	V50	222	2727	5200
	Surface Vertical Rod Exit Device - Weatherized	V50xW	No equal	No equal	No equal
	Surface Vertical Rod Exit Device - Top Rod Only	V51	2227LBR	No equal	5200LBR
	Surface Vertical Rod Exit Device - Top Rod Only - Weatherized	V51xW	No equal	No equal	No equal
4	Narrow Stile Rim Exit Device	V40xNS	No equal	No equal	No equal
	Narrow Stile Rim Exit Device - Weatherized	V40xNSxW	No equal	No equal	No equal
5	Narrow Stile Surface Vertical Rod Exit Device	V50xNS	No equal	No equal	No equal
	Narrow Stile Surface Vertical Rod Exit Device - Weatherized	V50xNSxW	No equal	No equal	No equal
	Narrow Stile Surface Vertical Rod Exit Device - Top Rod Only	V51xNS	No equal	No equal	No equal
	Narrow Stile Surface Vertical Rod Exit Device - Top Rod Only - Weatherized	V51xNSxW	No equal	No equal	No equal

TRIM CROSS REFERENCE CHART

Pulls & Plates

			VALUE SERIES®	Manufacturer A Exit Devices	Manufacturer B Exit Devices	Manufacturer C Exit Devices
BHMA Function	BHMA Definition	Description	Standard Value Series	22 Series	20 Series	51 Series
01	Exit Only	Cover Plate	01P 01PN	N/A	802-GTB	501
02	Pull When Dogged	Dummy Pull	02A 02AN	230DT	Thumbpiece trims only	702A
02	Pull When Dogged	Dummy Pull (Wire)	02WP	N/A	N/A	N/A
03	Key Retracts Latch Bolt	Night Latch Pull	03A 03AN	230NL	Thumbpiece trims only	703A
03	Key Retracts Latch Bolt	Night Latch Pull	03P 03PN	210NL	814-HTB	603
03	Key Retracts Latch Bolt	Night Latch - Cylinder Only - Pull by others	03WS	110NL	N/A	N/A

Lever Trims

			VALUE SERIES®	Manufacturer A Exit Devices	Manufacturer B Exit Devices	Manufacturer C Exit Devices
BHMA Function	BHMA Definition	Description	Standard Value Series	22 Series	20 Series	51 Series
08	Key Locks/Unlocks Lever	Classroom Lever	08BN	230L	Rose trims only	808A
09	Lever Active by Key; Locked when key removed	Night Latch Lever / Storeroom Lever	09BN	N/A	Rose trims only	N/A
14	Lever Always Active	Passage Lever	14BN	N/A	Rose trims only	814A
EU	Electric Lock/Unlock	Fail Safe/Fail Secure	EU2W	N/A	N/A	N/A

Function		Manufacturer A Exit Devices	Manufacturer B Exit Devices	Manufacturer C Exit Devices
	Standard Advantex	Standard 22 Series	Standard 20 Series	Standard 5000 Series
Hardwired Exit Alarm	EA	ALK	No equal	RALW
Battery Powered Exit Alarm	EB	No equal	No equal	RALK
Weatherized Battery Powered Exit Alarm	EB W	No equal	No equal	WALW
Electric Dogging	ED	No equal	No equal	No equal
Electric Latch Retraction	ER EX Request to Exit Switch Included	No equal	No equal	No equal
Weatherized Electric Latch Retraction	ER EX W Request to Exit Switch Included	No equal	No equal	No equal
Electric Lock/Unlock Lever	EU2W	No equal	No equal	No equal
Delayed Egress	EE	No equal	No equal	No equal
Electric Integration	EI	No equal	No equal	No equal
Electric Switching	ES	RXXLX	No equal	No equal
Request to Exit Signaling	EX	RX	No equal	TS
Weatherized Request to Exit Signaling	EX W	No equal	No equal	WTS
Request to Exit Switching for High Current	EXV	No equal	No equal	No equal
Weatherized Request to Exit Switching for High Current	EXV W	No equal	No equal	No equal

Exit Alarm (EA)

Price Add

Available on all non-weatherized VS Devices

\$526

Standard Package Includes:

- Switch monitors pushpad movement and triggers alarm
- Manual Key Arming standard or field-selectable 2-minute auto rearm
- Remote Alarm Relay output (std.) Common, Normally Open or Normally Closed Relay contacts
- Bypass Alarm Relay input (std.) Normally Open Relay Contacts
- Low-Battery Alert (std.), field-selectable option to remove backup battery / disable low-battery alert
- Cylinder Dogging (CD) standard or Less Dogging (LD - NOTE: Fire Rated devices come LD only)
- 120V to 12VAC Transformer and 9V Battery Backup
- Flexible 3' Conduit Loop and Endcap Connector
- Pushpad Signage "Push to Open Alarm Will Sound"

Options	Price Add
KS - Keystop feature installed	\$11
FC10 - 10' Flexible Conduit and fittings	\$117
LD - Less Dogging	N/C
BLK - Black pushpad (includes peel & stick door signage "Emergency Exit Only Alarm Will Sound")	N/C
IN - 220V to 24VAC Transformer substituted for standard transformer	N/C
277 - 277V to 24VAC Transformer substituted for standard transformer	\$53
LBM - Latch Bolt Monitoring - V40 only (alarm triggered by dead latch)	\$55
PT-5 - Power Transfer	\$230
EWH8-626 - Electric Hinge	\$551

Exit Alarm - Battery Powered (EB)

Price Add

Available on all non-weatherized VS Devices

MAP Policy Applies
See page 9

\$252

Standard Package Includes:

- Switch monitors pushpad movement and triggers alarm
- Green & Red LED, cylinder arming, 9-volt battery and piezo horn
- Cylinder Dogging (CD) standard or Less Dogging (LD - NOTE: Fire Rated devices come LD only)
- Pushpad Signage "Push to Open Alarm Will Sound"

Options	Price Add
KS - Keystop feature installed	\$11
FC3 - 3' Flexible Conduit and fittings	\$64
FC10 - 10' Flexible Conduit and fittings	\$117
LD - Less Dogging	N/C
BLK - Black pushpad (includes peel & stick door signage "Emergency Exit Only Alarm Will Sound")	N/C
LBM - Latch Bolt Monitoring - V40 only (alarm triggered by dead latch)	\$55
Accessories	
BE-961-1 - Battery Eliminator 9VDC Power Source	\$407

Weatherized Exit Alarm - Battery Powered (EB W)

Price Add

Available on all weatherized VS Devices - *Must specify weatherized option on exit device*

\$494

Standard Package Includes:

- Switch monitors pushpad movement and triggers alarm
- Manual Key Arming standard or field-selectable 2-minute auto rearm
- Remote Alarm Relay output (std.) Common, Normally Open or Normally Closed Relay contacts
- Bypass Alarm Relay input (std.) Normally Open Relay Contacts
- Low-Battery Alert (std.), field-selectable option to remove backup battery / disable low-battery alert
- Cylinder Dogging (CD) standard or Less Dogging (LD - NOTE: Fire Rated devices come LD only)
- 120V to 12VAC Transformer and 9V Battery Backup
- Flexible 3' Conduit Loop and Endcap Connector
- Pushpad Signage "Push to Open Alarm Will Sound"

Options

Price Add

KS - Keystop feature installed	\$11
LD - Less Dogging	N/C
BLK - Black pushpad (includes peel & stick door signage "Emergency Exit Only Alarm Will Sound")	N/C
FC3W - Weatherized 3' Flexible Conduit and fittings	\$103
FC10W - Weatherized 10' Flexible Conduit and fittings	\$236

Accessories

106595-5 - Battery Eliminator 9VDC Power Source in NEMA Enclosure	\$2,225
---	---------

Electric Dogging (ED)

Price Add

Available on all non-weatherized VS Devices

\$717

Standard Package Includes:

- On-board switching requires initial manual pushpad depression after electric activation
- Long-term dogging
- Flexible 3' Conduit Loop and Endcap Connector

(NOTE: A 24V power supply or logic controller is required for ED but not included.)

(NOTE: Most applications with ED require a power switch - See page 105)

Options

Price Add

IN - 220V to 24VAC Transformer	N/C
EX - Request to Exit Switching (example ED EX)	\$212
FC10 - 10' Flexible Conduit and fittings	\$117
PT-5 - Power Transfer	\$230
EWH8-626 - Electric Hinge	\$551

Accessories

CS462 Keypad (For other keypad and push button options, see page 105)	\$280
PP-5152-2 24VAC Transformer	\$127
24V Power Supply for filtered, regulated power and simplified fire loop connections	See page 68

Electric Latch Retraction with Request to Exit Switch (ER EX)

Price Add

Available on all non-weatherized VS Devices

\$1,544

Standard Package Includes

- Simultaneous latch and pushpad retraction
- Flexible 3' Conduit Loop and Endcap Connector
- Long-term dogging capability
- Request to Exit Switch

(NOTE: A Logic Controller and Power Supply is required for ER but not included in standard package)

Options	Price Add
FC10 - 10' Flexible Conduit and fittings	\$117
PT-5 - Power Transfer	\$230
EWH8-626 - Electric Hinge	\$551

Accessories

81-800 Power Supply Controller for Latch Retraction - Single Door	See page 66
82-800 Power Supply Controller for Latch Retraction - Pairs of Doors Simultaneous	See page 66
83-800 Power Supply Controller for Latch Retraction - Pairs of Doors Independent	See page 66

Weatherized Electric Latch Retraction with Request to Exit Switch (ER EX W)

Price Add

*Available on all weatherized VS Devices - **Must specify weatherized option on exit device***

\$2,233

Standard Package Includes:

- Weatherized simultaneous latch and pushpad retraction
- Long-term dogging capability
- Request to Exit Switch
- Weatherized flexible 3' Conduit Loop and Endcap Connector

(NOTE: A Power Supply is required for ER but not included in standard package. If mounting outside, NEMA enclosure required)

Options	Price Add
FC10W - Weatherized 10' Flexible Conduit and fittings	\$236

Accessories

81-800 Power Supply Controller for Latch Retraction - Single Door	See page 66
82-800 Power Supply Controller for Latch Retraction - Pairs of Doors Simultaneous	See page 66
83-800 Power Supply Controller for Latch Retraction - Pairs of Doors Independent	See page 66

Electric Switching (ES)

Price Add

Available on non-weatherized V40 Devices

\$234

Standard Package Includes:

- Switching monitors dead latch and outside trim input
- HD (Hex Dogging) standard or Less Dogging (LD - NOTE: Fire Rated devices come LD only)
- Black pushpad with peel & stick door signage "Push to Exit Alarm Will Sound"

(NOTE: A Logic Controller is required for ES but not included in standard package)

Options	Price Add
KS - Keystop feature installed	\$11
FC10 - 10' Flexible Conduit and fittings	\$117
CD - Cylinder Dogging	N/C
LD - Less Dogging	N/C
RWE - Red pushpad with white signage (English) - other languages available	N/C
PT-5 - Power Transfer	\$230
EWH8-626 - Electric Hinge	\$551

Delayed Egress (EE)

Price Add

Available on all non-weatherized VS Devices

\$2,294

Standard Package Includes:
 - Switch monitors latch bolt and triggers alarm
 - 15-second Delayed Egress with dead latch monitoring
 - 15-second arming delay (AD) with extended bypass (alarm arms after door closes)
 - 1-second nuisance delay
 - Comes standard with 24V Filtered and Regulated Power Supply with simplified fire loop connections
(NOTE: Detex Power Supply required and included with standard EE Package, can power both devices for a pair of doors, specify V40 EExPS0 for second door)
 - Remote Alarm Relay output (std.) Common, Normally Open or Normally Closed Relay contacts and Remote Reset
 - Bypass Alarm Relay input (std.) Normally Open Relay Contacts
 - Low-Battery Alert (std.), field-selectable option to remove backup battery / disable low-battery alert
 - Cylinder Dogging (CD) standard or Less Dogging (LD - NOTE: Fire Rated devices come LD only)
 - Delayed Egress Door Sign (ECL-395 English, 15 seconds, Red)
 - Flexible 3' Conduit Loop and Endcap Connector
 - Pushpad Signage "Push to Open Alarm Will Sound"

Options

Price Add

KS - Keystop feature installed	\$11
LD - Less Dogging	N/C
30 - 30-Second Delayed Egress (example EE 30)	N/C
BLK - Black pushpad (includes peel & stick door signage "Emergency Exit Only Alarm Will Sound")	N/C
FC10 - 10' Flexible Conduit and fittings	\$117
SA - Silent Arming	\$242
PT-5 - Power Transfer	\$230
EW8-626 - Electric Hinge	\$551
L9 - Less Battery	\$11
SI - Status Indicator	\$9
L9xSI - Less Battery & Status Indicator	\$20
PS0 - Less Power Supply	Subtract \$225

Delayed Egress With External Logic (EEX)

Price Add

Available on non-weatherized VS devices 36" and longer

\$1,214

Standard Package Includes:
 -Hex dogging (CD & LD available)
 -Fire and hurricane rated available
 -Includes delay egress 15 second door sign
(NOTE: A Logic Controller is required but not included in standard package)

Options

Price Add

12-800 Logic Controller	See page 68
-------------------------	-------------

Delayed Egress With External Logic for Outdoor Use (EEX W)

Price Add

Available on weatherized VS devices 36" and longer - *Must specify weatherized option on exit device*

\$1,254

Standard Package Includes:
 -Hex dogging (CD & LD available)
 -Fire and hurricane rated available
 -Includes delay egress 15 second door sign
(NOTE: A Logic Controller is required but not included in standard package)

Options

Price Add

106595-1 Logic Controller in NEMA enclosure for use outdoors	See page 68
--	-------------

Electric Integration (EI)

Price Add

Available on non-weatherized V40 Devices

\$275

Standard Package Includes:

- Switches to monitor dead latch and outside trim input
- Green and Red LED, cylinder arming and piezo horn (logic & power supply separate)
- Cylinder Dogging (CD) standard or Less Dogging (LD - NOTE: Fire Rated devices come LD only)
- Black pushpad with peel & stick door signage "Push To Exit Alarm Will Sound"

(NOTE: A Logic Controller is required for EI but not included in standard package)

Options	Price Add
KS - Keystop feature installed	\$11
LD - Less Dogging	N/C
RWE - Red pushpad with white signage (English) - other languages available	N/C
FC3 - 3' Flexible Conduit and fittings	\$64
FC10 - 10' Flexible Conduit and fittings	\$117
PT-5 - Power Transfer	\$230
EW8-626 - Electric Hinge	\$551

Accessories

10-800 or 11-800 - Logic Controller & Power Supply for Electric Integration

See page 68

Request to Exit Signaling (EX)

Price Add

Available on all non-weatherized VS Devices

\$212

Standard Package Includes:

- Switch monitors pushpad
- Hex Dogging (HD) standard or Less Dogging (LD - NOTE: Fire Rated devices come LD only)
- Black pushpad with peel & stick door signage "Push To Exit Alarm Will Sound"
- Flexible 3' Conduit Loop and Endcap Connector

Options	Price Add
FC10 - 10' Flexible Conduit and fittings	\$117
CD - Cylinder Dogging	N/C
LD - Less Dogging	N/C
RWE - Red pushpad with white signage (English) - other languages available	N/C
PT-5 - Power Transfer	\$230
EW8-626 - Electric Hinge	\$551

Weatherized Request to Exit Signaling (EX W)

Price Add

*Available on all weatherized VS Devices - **Must specify weatherized option on exit device***

\$82

Standard Package Includes:

- Weatherized Switch monitors pushpad
- Cylinder Dogging (CD) standard or Less Dogging (LD - NOTE: Fire Rated devices come LD only)
- Red pushpad wrap with White Signage (English) "Push To Exit Alarm Will Sound"
- Weatherized flexible 3' Conduit Loop and Endcap Connector

Options	Price Add
FC10W - Weatherized 10' Flexible Conduit and fittings	\$236
CD - Cylinder Dogging	N/C
LD - Less Dogging	N/C
Black pushpad with peel & stick door signage "Push To Exit Alarm Will Sound"	N/C

Request to Exit Signaling for High Current (EXV)

Price Add

Available on all non-weatherized VS Devices

\$332

Standard Package Includes:

- 3-Amp Switch monitors pushpad
- Hex Dogging (HD) standard or Less Dogging (LD - NOTE: Fire Rated devices come LD only)
- Flexible 3' Conduit Loop and Endcap Connector

Options

Price Add

FC10 - 10' Flexible Conduit and fittings	\$117
CD - Cylinder Dogging	N/C
LD - Less Dogging	N/C
2 - Includes 2 High Current Switches (EXV2)	\$327
PT-5 - Power Transfer	\$230
EWH8-626 - Electric Hinge	\$551

Weatherized Request to Exit Signaling for High Current (EXV W)

Price Add

*Available on all weatherized VS Devices - **Must specify weatherized option on exit device***

\$180

Standard Package Includes:

- 3-Amp Switch monitors pushpad
- Hex Dogging (HD) standard or Less Dogging (LD - NOTE: Fire Rated devices come LD only)
- Flexible 3' Conduit Loop and Endcap Connector



Options

Price Add

FC10W - Weatherized 10' Flexible Conduit and fittings	\$123
CD - Cylinder Dogging	N/C
LD - Less Dogging	N/C
2 - Includes 2 High Current Switches (EXV2)	\$327
Black pushpad with peel & stick door signage "Push To Exit Alarm Will Sound"	N/C

Electric Slide-In Filler Kits (For Service & Repair Parts - Contact Factory)			Price
SIFV-EB	Exit Alarm 9VDC (Battery Powered) Includes pushpad monitoring	SIFV-EB-36"	\$345
		SIFV-EB-48"	\$361
SIFV-EB-W	Weatherized Exit Alarm 9VDC (Battery Powered) Includes pushpad monitoring, remote signal & remote bypass	SIFV-EB-W-36"	\$908
		SIFV-EB-W-48"	\$924
SIFV-EA	Exit Alarm 12VAC - 24VAC (Hardwired) Includes pushpad monitoring, remote signal & remote bypass	SIFV-EA-36"	\$622
		SIFV-EA-48"	\$638
SIFV-EX	Request to Exit Switching Includes pushpad monitoring Specify Cylinder Dogging (CD), Less Dogging (LD) or Hex Dogging (HD)	SIFV-EX-36"	\$345
		SIFV-EX-48"	\$361
SIFV-EX-W	Weatherized Request to Exit Switching Includes weatherized pushpad monitoring Specify Cylinder Dogging (CD), Less Dogging (LD) or Hex Dogging (HD)	SIFV-EX-W-36"	\$563
		SIFV-EX-W-48"	\$579
HD-CD-LD Slide-In Filler Kits			Price
SIFV-LD	Less Dogging Slide-In Filler Kit	SIFV-LD-36"	\$32
		SIFV-LD-48"	\$39
SIFV-HD	Hex Key Dogging Slide-In Filler Kit	SIFV-HD-36"	\$76
		SIFV-HD-48"	\$76
SIFV-CD	Cylinder Dogging Slide-In Filler Kit	SIFV-CD-36"	\$76
		SIFV-CD-48"	\$76
Shaft Extension			Price
SE-2	Shaft Extension Kit for Lever Trims for 2 - 2-1/2" thick door		\$91
SE-25	Shaft Extension Kit for Lever Trims for 2-1/8 - 2-5/8" thick door		\$91
SE-3	Shaft Extension Kit for Lever Trims for 2-5/8 - 3-1/8" thick door		\$142
SE-35	Shaft Extension Kit for Lever Trims for 3-1/8 - 3-5/8" thick door		\$142
SE-4	Shaft Extension Kit for Lever Trims for 3-5/8 - 4-1/4" thick door		\$142
SE-65	Shaft Extension Kit for Lever Trims for 6 - 6-5/8" thick door		\$142

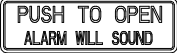
Strike Kits		Price
94	Double Door Strike Kit with Tamper Resistant and Standard Fasteners (for V40 Series)	\$96
96	Surface Non-Roller Strike (for V50/V51 Series)	\$50
96B	Dustproof Strike (for V50 Series)	\$70
98	Semi-Mortise Strike (for V40 Series)	\$70
99	Surface Strike (for V40 Series)	\$58
SHK1	Strike Hook Kit (1 per package)	\$29
Hex Dogging Key		Price
HDK	Hex Dogging Key	\$11
Mounting Accessories		Price
NSK	Narrow Stile Door Kit (Can work for V40 and V50) Converts Standard Value Series Device to fit 2" stile - Specify Device Finish: 628 or 711	\$139
NSK-SVR	Narrow Stile Door Kit For Surface Vertical Rods (Only works for V50) Converts Standard Value Series Device to fit 2" stile - Specify Device Finish: 628 or 711	\$69
SN1	Sex Nut Kit 1/4"-20 (2 per pkg) - Specify Finish: 606, 613, 630	\$29
SSK3	Torx® Security Screw Kit for Value Series - Includes security tip driver and tamper resistant fasteners	\$64
Rod Covers and Bottom Bolt Guards		Price
RC	Rod Covers	\$245
BG	Bottom Bolt Guard	\$147
RCxBG	Rod Covers and Bottom Bolt Guard	\$392
Glass Bead Kit		Price
GB5	Glass Bead Kit - V50 Series (Used as 1/4" shim for flush doors with light kit moldings)	\$489
GB15	Glass Bead Kit - V40 Series (Used as 1/4" shim for flush doors with light kit moldings)	\$111
Flexible Conduit Loop Kits, Armored Cable Kits and Power Transfers		Price
FC3	Flex Conduit Kit includes 3' conduit and fittings	\$64
FC10	Flex Conduit Kit includes 10' conduit and fittings	\$117
FC3W	Weatherized Flex Conduit Kit includes 3' conduit, fittings and waterproof wire nuts	\$103
FC10W	Weatherized Flex Conduit Kit includes 10' conduit, fittings and waterproof wire nuts	\$236
AL18	Surface Mount Flex Armor Loop, Aluminum Finish, 18" - Mounted to door and wall	\$184
JB-R	Junction Box with Relay	\$518
PT-5	Power Transfer	\$230
EWH8-626	Electric Hinge	\$551

Delayed Egress Peel & Stick Door Signage Chart			Price
PUSH UNTIL ALARM SOUNDS - DOOR CAN BE OPENED IN XX SECONDS			
ECL-395	English - 15 Second - Red (Std.)		\$23
ECL-395-1	English - 30 Second - Red		\$23
ECL-395-2	French/Canadian - 15 Second - Red		\$23
ECL-395-3	French/Canadian - 30 Second - Red		\$23
ECL-395-4	Spanish - 15 Second - Red		\$23
ECL-395-5	Spanish - 30 Second - Red		\$23
ECL-395-6	French - 15 Second - Green		\$23
ECL-395-7	French - 30 Second - Green		\$23
ECL-395-8	German - 15 Second - Green		\$23
ECL-395-9	German - 30 Second - Green		\$23
ECL-395-10	Chinese - 15 Second - Red		\$23
ECL-395-11	Chinese - 30 Second - Red		\$23
ECL-395-12	English European - 15 Second - Green		\$23
ECL-395-13	English European - 30 Second - Green		\$23
Peel & Stick Door Sign			Price
PUSH TO OPEN - ALARM WILL SOUND			
101802-1	English - Green		\$26
101802-2	French - Green		\$26
101802-3	German - Green		\$26
101802-4	Chinese - Red		\$26
101802-5	Spanish - Red		\$26
101802-6	French/Canadian - Red		\$26
Delayed Egress Outdoor Signage Chart			Price
PUSH UNTIL ALARM SOUNDS - DOOR CAN BE OPENED IN 15/30 SECONDS			
101906	English - 15 Second (Metal Sign - Non-Adhesive)		\$128
101906-1	English - 30 Second (Metal Sign - Non-Adhesive)		\$128
Optional Value Series Pushpad Signage Chart			
PUSH TO OPEN - ALARM WILL SOUND			
		36"	48"
105417-1	Pushpad wrap kit - 3-foot Red, white lettering	\$29	
105417-2	Pushpad wrap kit - 4-foot Red, white lettering	\$29	
105417-3	Pushpad wrap kit - 3-foot Black, no lettering	\$29	
105417-4	Pushpad wrap kit - 4-foot Black, no lettering	\$29	

MODEL NO.	DESCRIPTION	PRICE
GTPLKIT	Gate Plate Kit - Includes Gate Latch Protector (GTPLGRD), Strike Latch Receiver Bracket (GTSTKBKT), Adjustable Gate Plate (GTPL)	\$1,245

MODEL NO.	DESCRIPTION	PRICE
GTPL	Adjustable Gate Plate - Fits Single Gates 32" - 52" wide Fits square or round gate frames Plate comes without mounting holes for device	\$901
GTSTKBKT	Strike Latch Receiver Bracket	\$361
GTPLGRD	Gate Latch Protector	\$190
03GS	Optional 03 function cylinder trim used on gates (Rim Cylinder sold separately)	\$184
08GS	Spacer for Wide Lever Trim	\$197
08GSN	Spacer for Narrow Lever Trim	\$197

All above parts available in black (specify -BLK - ex. GTPL-BLK) and gray (std.) finish
For rim applications (further fabrication to opening required for SVR applications)

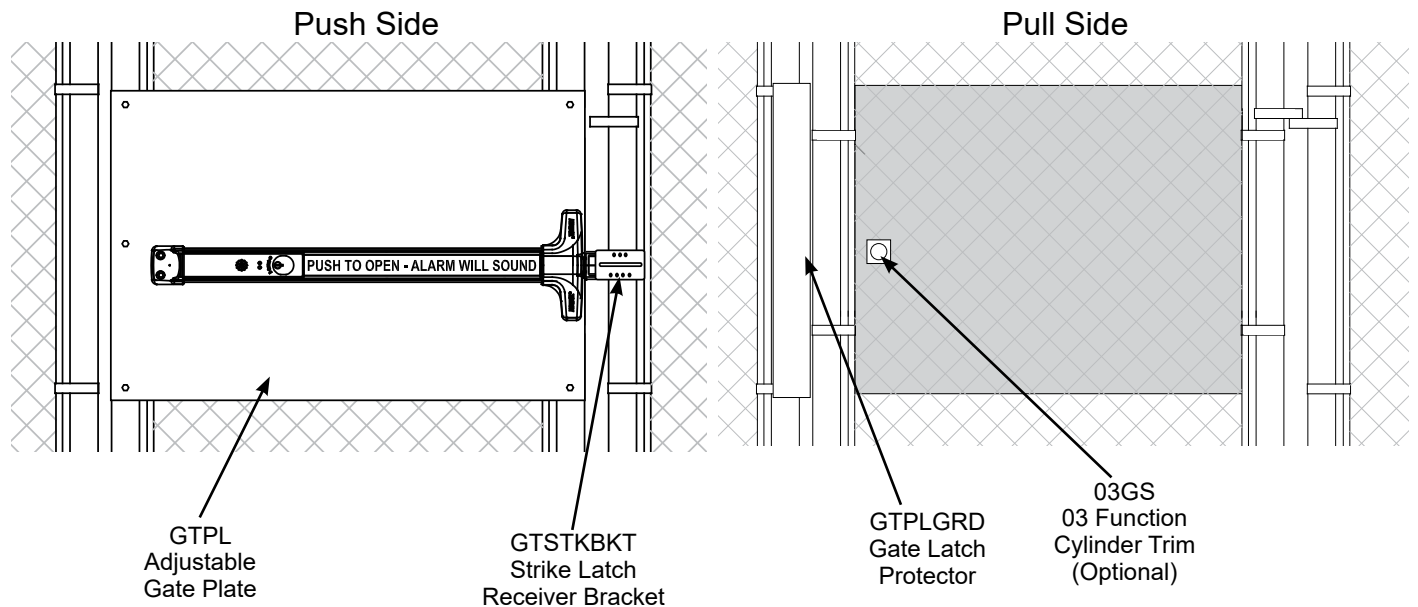

EXIT DEVICE SOLD SEPARATELY

For more information, see Value Series weatherized exit devices

PS80 SERIES™

CONTROLLERS AND POWER SUPPLIES

POWER SUPPLIES Replaces 80-800 and 90-800 Power Supplies

For use with Delayed Egress (EE) and Access Control

	MODEL NO.	DESCRIPTION	PRICE
	PS80	24VDC Power Supply - 2A continuous Includes separate 12V output module	\$1,036

* Cover lock and keys sold separately

POWER SUPPLY CONTROLLERS Replaces 81-800, 82-800 and 83-800 Power Supply Controllers

For use with Latch Retraction (ER)

	MODEL NO.	DESCRIPTION	PRICE
	PS82	Controller and Power Supply - 2A continuous For single door, simultaneous pairs of doors and independent pairs of doors Includes separate 12V output module	\$1,740

* Cover lock and keys sold separately

PS80 / PS82 OPTIONS AND ACCESSORIES

	MODEL NO.	DESCRIPTION	PRICE
	BB	Battery Backup Kit - Includes Battery Charging Circuit and 2 batteries	N/C
	L	Cover Lock and 2 keys	Add \$55
	LT	Less Transformer *NOTE: Requires 24VAC input	N/C



Series 800

POWER SUPPLY CONTROLLERS

	MODEL NO.	DESCRIPTION	PRICE
	81-800*	Controller and Power Supply - 1.0A continuous Powers and controls ER device for 1 door with signal output for 1 operator	\$1,540
	82-800*	Controller and Power Supply - 2.0A continuous Powers and controls ER device for 1 pair of doors with signal output for 1 operator	\$1,740
	83-800*	Controller and Power Supply - 2.0A continuous Powers and controls ER device for 2 independent doors with signal output for 2 operators	\$2,138
	x220 M12	Optional - 220VAC Input 12-Volt Module	Add \$165 Add \$213

* Cover lock and keys sold separately - See Series 800 Accessories (p. 69) to order.

POWER SUPPLIES

	MODEL NO.	DESCRIPTION	PRICE
	90-800	120VAC/24VDC Power Supply - 1.0A continuous Can be used with ED, EE, EM products	\$847
	90-800IN 90-800LT	Optional - 240VAC Input Less Transformer	Add \$126 Subtract \$27
	80-800*	12 or 24VDC Power Supply - 1.0A continuous Can be used with ED, EE, EM products NOTE: Battery Charging Circuit included (Battery sold separately)	\$1,036
	x220 M12	Optional - 220VAC Input 12-Volt Module	Add \$165 Add \$213

* Cover lock and keys sold separately - See Series 800 Accessories (p. 69) to order.

POWER SUPPLY CONTROLLERS

	MODEL NO.	DESCRIPTION	PRICE
 <p>84-800 or 85-800 Also includes wire harness with wiring</p> <p>Remote Indicating Unit (RIU)</p>	84-800	Controller and Power Supply with Remote Indicating Unit - 1.0A continuous - Powers and controls EE ER device for 1 door with signal output for 1 operator	\$3,286
	85-800	Controller and Power Supply with Remote Indicating Unit - Controller and Power Supply - 2.0A continuous Powers and controls EE ER device for 1 pair of doors with signal output for 1 operator	\$4,182
<p>* Standard defaults include: 15-second Arming, 15-second Delayed Egress, English Signage (RWE), 3-chirp Arming, Door Signal Module (DSM), Gray Remote Indicating Unit (RIU), Surface mounting, Dummy Plug (not installed), Rearm using key or access control (Powers 2 EE ER Exit Devices - for 85-800 units only)</p>			

CONFIGURABLE OPTIONS - 84-800 / 85-800









MODEL NO.	DESCRIPTION	PRICE
8X-810	1-second Arming	N/C
8X-803	30-second Delayed Egress	N/C
SA	Silent Arming	Add \$224
M12	12VDC Module (Replaces DSM when ordering 85-800)	Add \$213
BLK	Black Remote Indicating Unit (RIU)	Add \$136
F	Flush Mounting	N/C
KS	Keystop	Add \$11
SSK	Security Screws for RIU	Add \$27
RKO	Rearm using Key only	Add \$273
ER	Powers (1) EE ER and (1) ER Exit Device (for 85-800 units only)	Add \$273
EE	Powers (1) EE ER and (1) EE Exit Device (for 85-800 units only)	Add \$273

Signage - Other languages available - contact factory



How To Orders

LOGIC CONTROLLERS

	MODEL NO.	DESCRIPTION	PRICE
	10-800*	Series 800 Controller - Stand-Alone 120VAC/24VDC System contains back box, transformer and Series 800 electronics	\$2,240
	11-800*	Series 800 Controller - Stand-Alone 120VAC/24VDC System contains back box, upper back pan and flip-up insert, 24-point terminal strip, transformer and Series 800 electronics	\$2,539
	60-2RMF	Relay board (2) DPDT, 24VDC output relays, sequence or independent, wet or dry, field selectable - Includes 12VDC@150mA output tap. Used with Series 800 logic controllers, offers an integration solution to multi controls and single-point terminations.	Add \$636
	12-800	Series 800 Controller - Stand-Alone 120VAC/24VDC System contains back box, upper back pan and flip-up insert, 24-point terminal strip, transformer and Series 800 electronics Prewired at factory and labeled with connections for use in delayed egress applications (single or pairs) No Delayed Egress (Specify 12-800) 15 second Delayed Egress with Remote Bypass (for 10 EX W) (Specify DE1) 15 second Delayed Egress (for V40 EX W) (Specify DE2) 15 second Delayed Egress with Remote Bypass (for 10 ER EX) (Specify DE3) 15 second Delayed Egress without Maglock (for WDE EasyKit) (Specify DE5)	\$2,656
	106595-1	For use on Single or Pairs of Delayed Egress System doors with weatherized controlled egress exit devices, labeled for use outdoor (106595-1 is supplied inside NEMA 4X enclosure and can be installed outdoors – attach conduit to bottom of NEMA 4X enclosure)	\$4,864
	30-800*	Series 800 Controller - 120VAC/24VDC Surface Box - Zinc Plated System contains back box w/metal stand-off, lid and Series 800 electronics. Requires low-voltage remote source of power	\$1,731
	31-800	Series 800 Controller - 120VAC/24VDC Flat Mount Plate Requires low-voltage remote source of power	\$1,794
	40-800*	Series 800 Controller - 120VAC/24VDC Surface Box - Black System contains back box, upper back pan and flip-up insert with Series 800 electronics. Requires low-voltage remote source of power	\$1,941
	41-800* **	Series 800 Controller - 120VAC/24VDC Surface Box - Black Without Flip-up insert unit. Requires low-voltage remote source of power	\$1,883
	50-800	Circuit Board - 24VAC/24VDC - Comes with 5 stand-offs, requires non-conductive support studs for proper installation	\$1,883

*Cover lock and keys not included - See Controller & Power Supply Accessories (p. 69) to order lock

** This application is generally used for integrated applications that require additional splice chamber room or for the pass-through of cable, wire or circuit boards associated with low voltage systems. Preparation of upper back pan and flip-up portion of insert to suit other manufacturers components is available. For custom applications, please call for quotation.

CONTROLLER OPTIONS

MODEL NO.	DESCRIPTION	PRICE
LT	Less Transformer Available for all Logic Controllers	Subtract \$50

CONTROLLER & POWER SUPPLY OPTIONS

MODEL NO.	DESCRIPTION	PRICE
L	Cover Lock with 2 Keys	Add \$55
T	Tamper Proof Sensor	Add \$55
TL	Tamper Proof Sensor and Cover Lock with 2 Keys	Add \$110
K1	Relay	Add \$36

POWER SUPPLY ACCESSORIES

	MODEL NO.	DESCRIPTION	PRICE
	70-12B	Battery 12VDC 4AH	\$169
	70-24B	Battery 24VDC 4AH 2 batteries provided Includes linking cable (Battery Box not Included)	\$318
	M12	12 Volt Module	Add \$213

Signage sold separately - See ECL-395 (p. 64) and EA-561 (p. 102)

CONTROLLER ACCESSORIES

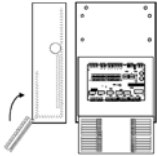
	MODEL NO.	DESCRIPTION	PRICE
	60-06	Folding Insert Tray Add this to 10-800 Controller to provide space for digital timer or door call module	\$316

Signage sold separately - See ECL-395 (p. 64) and EA-561 (p. 102)



Standard Mullions	PRICE
90KRx7 - Keyed Removable Mullion - 7-foot	\$1,217
90KRx8 - Keyed Removable Mullion - 8-foot	\$1,217
90KRx10 - Keyed Removable Mullion - 10-foot	\$1,377
Fire Rated Mullions	
F90KRx7 - Fire Rated Keyed Removable Mullion - 7-foot	\$1,377
F90KRx8 - Fire Rated Keyed Removable Mullion - 8-foot	\$1,537

Shipped less rim cylinder - Rim Cylinder available at additional cost (see p. 94)

NOTE: Fire Rated Listing allows field location of strike. Detex Fire Rated Mullion can be strike-prepped in the field.

Detex Fire Rated Mullion can be used with other manufacturers' exit devices that are fire rated for pairs of doors with a mullion.

ELECTRIFIED KEYED REMOVABLE MULLIONS



Electrified Mullions	PRICE
90KREx7 - Electrified Keyed Removable Mullion - 7-foot	\$1,481
90KREx8 - Electrified Keyed Removable Mullion - 8-foot	\$1,481
90KREx10 - Electrified Keyed Removable Mullion - 10-foot	\$1,641

Shipped less rim cylinder - Rim Cylinder available at additional cost (see p. 94)

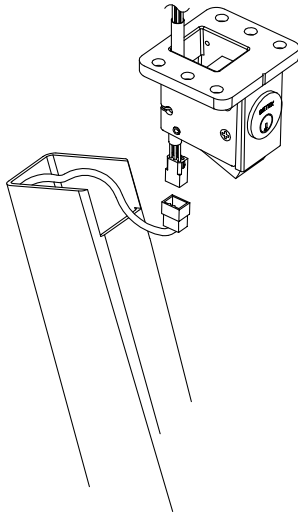



Removable Mullions	PRICE
90Rx7 - Removable Mullion (Not Keyed) - 7-foot	\$1,130
90Rx8 - Removable Mullion (Not Keyed) - 8-foot	\$1,130
Fire-Rated Removable Mullions	
F90Rx7 - Fire Rated Removable Mullion (Not Keyed) - 7-foot	\$1,290
F90Rx8 - Fire Rated Removable Mullion (Not Keyed) - 8-foot	\$1,290
Hurricane Rated Mullions	
H90Rx7 - Hurricane Rated Removable Mullion (Not Keyed) - 7-foot	\$1,599
H90Rx8 - Hurricane Rated Removable Mullion (Not Keyed) - 8-foot	\$1,599
Fire and Hurricane Rated Mullions	
FH90Rx7 - Fire and Hurricane Rated Removable Mullion (Not Keyed) - 7-foot	\$1,649
FH90Rx8 - Fire and Hurricane Rated Removable Mullion (Not Keyed) - 8-foot	\$1,649

AO19 SERIES®

Automatic Operator

Select from list below and fax to 800-653-3839

*NOTE: Operator always mounted inside of building
Viewed from mounting side of door*

- Single Door 39.5" Right Hand Push AL
 Qty _____ 45.5" Left Hand Push 11" + reveal BZ
 52" Pull Max reveal on a pull 2.5"

LH Push

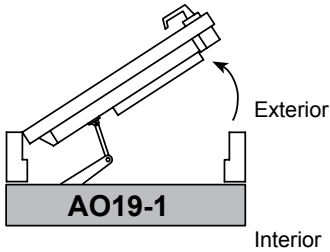

RH Push

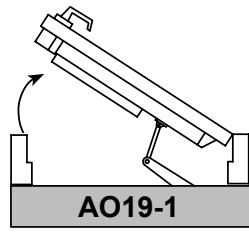

LH Pull

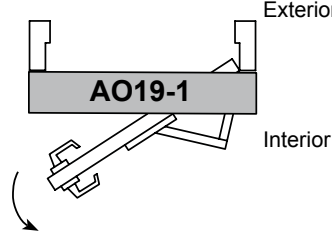

RH Pull

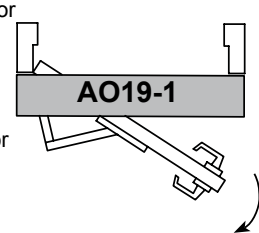

- Double Door (Twin) 75.5" Push AL Simultaneous
 Qty _____ 92" Push deep (11" reveal) BZ Independent
 100" Pull Max reveal on a pull 2.5"

Double Door (Twin) Push

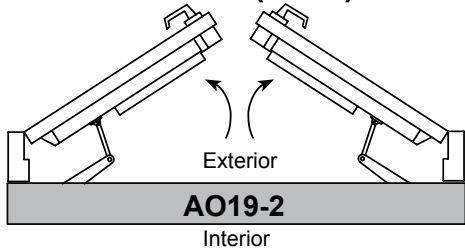

Double Door (Twin) Pull

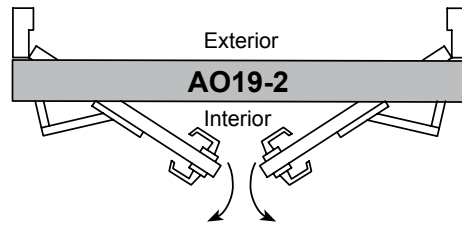

- Double Egress (Dual) Door 75.5" Right Hand AL Simultaneous
 Qty _____ 92" Left Hand BZ Independent
 100"

Dual Egress Door RH

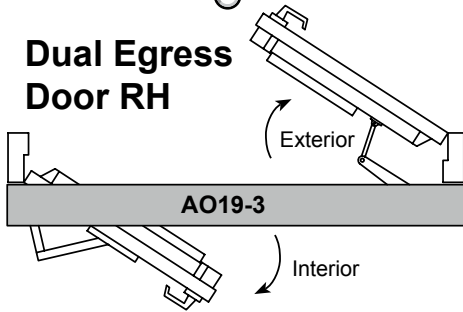

Dual Egress Door LH

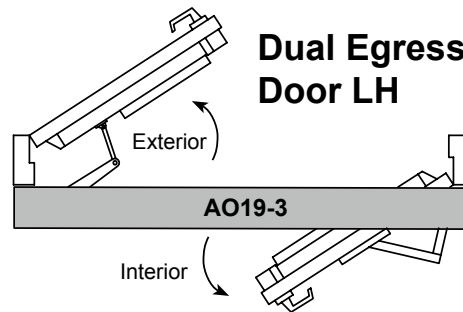

Distributor: _____ Date: _____
 Ph # _____ Email: _____ PO # _____
 Comments: _____
 Model # _____ x (length) _____ x (push/pull/dual) _____ x (AL/BZ) _____

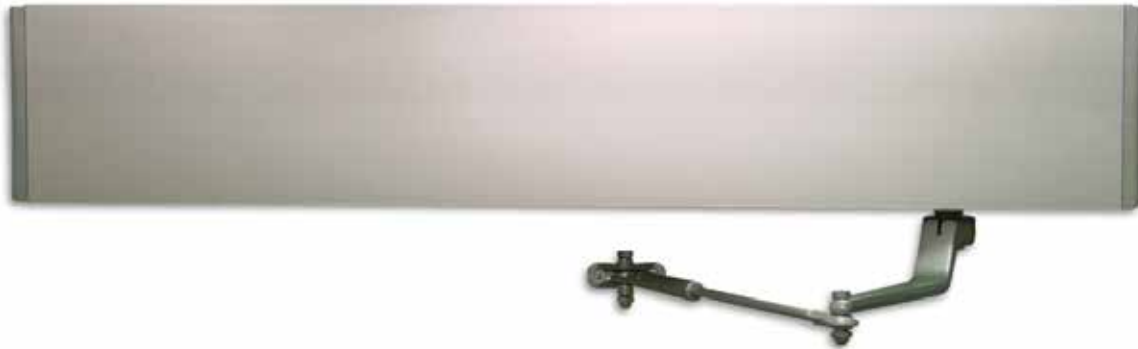

Model Number	Description	Finish	
		Clear (xAL)	Bronze (xBZ)
AO19-1xLH Push	Single Door Left Hand Push	\$5,880	\$5,880
AO19-1xRH Push	Single Door Right Hand Push	\$5,880	\$5,880
AO19-1xLH Pull	Single Door Left Hand Pull	\$5,880	\$5,880
AO19-1xRH Pull	Single Door Right Hand Pull	\$5,880	\$5,880

AO19-1 DEVICE COMES STANDARD WITH
 * AL - Clear Finish
 * 39.5" Device for 3-foot doors

OPTIONS

LIST PRICE

45.5" device for 42" doors	N/C
52" device for 48" doors	N/C
Custom lengths 26-52"	Add \$160
Special lengths shorter than 26"	Contact Factory
Special lengths longer than 52"	Contact Factory
DEEP - required for doors with reveals over 11" (push type only)	Add \$90
FLAT - substitute flat arm (provides 1-3/4" of additional headroom at top of door)	Add \$90



Model Number	Description	Finish	
		Clear (xAL)	Bronze (xBZ)
AO19-2 Push	Double Door Push	\$11,101	\$11,101
AO19-2 Pull	Double Door Pull	\$11,101	\$11,101

OPTIONS

LIST PRICE

AO19-2 DEVICE COMES STANDARD WITH
 * AL - Clear Finish
 * 75.5" Device for pairs of 3-foot doors

92" device for pairs of 44" doors	N/C
100" device for pairs of 48" doors	N/C
Custom lengths 60-100"	Add \$160
Special lengths shorter than 60"	Contact Factory
Special lengths longer than 100"	Contact Factory
DEEP - required for doors with reveals over 11" (push type only)	Add \$177
FLAT - substitute flat arm (provides 1-3/4" of additional headroom at top of door)	Add \$177
Independent - allows each door to operate independently	Add \$90



Model Number	Description	Finish	
		Clear (xAL)	Bronze (xBZ)
AO19-3xRH	Double Egress Doors - RH Push/RH Pull	\$11,101	\$11,101
AO19-3xLH	Double Egress Doors - LH Push/LH Pull	\$11,101	\$11,101

AO19-3 DEVICE COMES STANDARD WITH

- * AL - Clear Finish
- * 75.5" Device for pairs of 3-foot doors



OPTIONS

LIST PRICE

92" device for pairs of 44" doors	N/C
100" device for pairs of 48" doors	N/C
Custom lengths 60-100"	Add \$160
Special lengths shorter than 60"	Contact Factory
Special lengths longer than 100"	Contact Factory
DEEP - required for doors with reveals over 11" (push type only)	Add \$177
FLAT - substitute flat arm (provides 1-3/4" of additional headroom at top of door)	Add \$177
Independent - allows each door to operate independently	Add \$90

NOTES

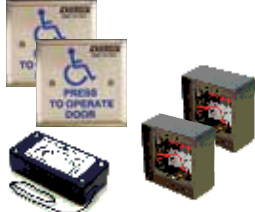
Single Door Kits



	Part No.	Description	Price
	104792-HSS	4-1/2" Square Button Wireless Single Door Kit - Includes (2) 4-1/2" Square HSS-Detex Pushplate Switch (104755) (2) Wall-Mount Boxes / Transmitter (104753) (1) Multi-Mode Receiver (104752)	\$868
	104791-2	4-1/2" Square Button Hardwired Single Door Kit - Includes (2) 4-1/2" Square HSS-Detex Pushplate Switch (104755) (2) 4-1/2" Square Low-Profile Mounting Box (104738-1020)	\$710

Jamb Mount Kits

	Part Number	Qty.	Description	Price
	104741-HSS	1 kit	Jamb Button Wireless Single Door Kit - Includes (2) Jamb Pushplate Switch (104739-HSS) (2) Jamb-Mount Box with Transmitter (104753-J) (1) Multi-Mode Receiver (104752)	\$993

For other pushplate switch options, see website



Vestibule Door Kits

	Part Number	Qty.	Description	Price
	104786-HSS	1 kit	<u>4-1/2" Square Button Wireless Vestibule Kit</u> - Includes (2) 4-1/2" Square Pushplate Switch (104755-HSS) (2) Wall-Mount Box with Transmitter (104753) (1) Double Vestibule Pushplate Switch (104744-HSS) (1) Dual Vestibule Button Box / Transmitter (104753-V) (2) Multi-Mode Receiver (104752)	\$1,810
	105388-HSS	1 kit	<u>4-1/2" Square Button Wireless Vestibule Sequencing Kit</u> - Includes (2) 4-1/2" Square Pushplate Switch (104755-HSS) (2) Wall-Mount Box/Sequencing Transmitter (104753-STX) (1) Double Vestibule Pushplate Switch (104744-HSS) (1) Dual Vestibule Button Box / Transmitter (104753-V) (2) Multi-Mode Receiver (104752)	\$2,009
	105387-HSS	1 kit	<u>4-1/2" Square Button Wired Vestibule Kit</u> - Includes (2) 4-1/2" Square Pushplate Switch (104755-HSS) (1) Double Vestibule Pushplate Switch (104744-HSS) (2) Low-Profile Mounting Box (104738-1020) (1) Dual Vestibule Button Box (104738-1015)	\$1,108

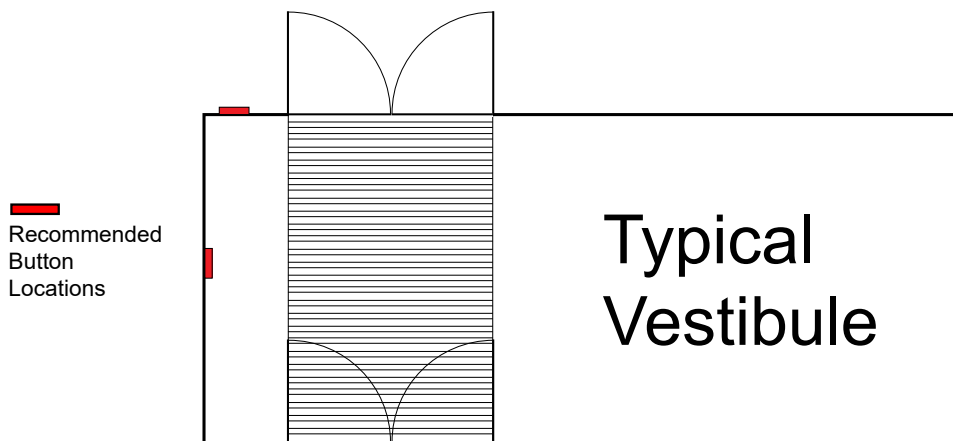
For other pushplate switch options, see website



Touchless Kits

	PART NO.	DESCRIPTION	PRICE
	NXG-KIT	4-1/2" Square Touchless Button Wireless Single Door Kit - Includes (2) 4-1/2" Square Wireless Touchless Switch (NXG-SW) (1) Coordinator (NXG-SCOR)	\$2,069
	NXG-2Wire-IR-A	4-1/2" Square Touchless Button Single Door Kit - Includes (2) 4-1/2" Square Hardwired Touchless Switch, 4-wire (NG-IR-A) (1) Control Module (NXG-2Wire-Module)	\$1,699

Hardwired Touchless

PART NO.	DESCRIPTION	PRICE
NXG-IR-A	4-1/2" Square Hardwired Touchless Switch, 4-wire	\$609
NXG-2Wire-Module	Control Module for NXG-IR-A, For upgrading existing hardwired system to touchless (1 module per operator required)	\$330



Wireless Touchless

PART NO.	DESCRIPTION	PRICE
NXG-SW	4-1/2" Infrared Wireless Touchless Activation Switch	\$698
NXG-SCOR	Wireless Touchless Coordinator	\$513



Touchless Service & Repair

PART NO.	DESCRIPTION	PRICE
NXG-FP	NXG-IR-A Replacement Face Plate	\$109

Post Kits

		PART NO.	QTY.	DESCRIPTION	PRICE
		104788-1	1 kit	<u>Single Button Wireless Post Kit</u> - Kit includes items & quantities for activation on one side of opening: (1) 4-1/2" Square Pushplate Switch (104755) (1) Post Transmitter (104753-P) (1) Single Button Post, Aluminum (105380-1)	\$1,917
		104788-2	1 kit	<u>Single Button Wireless Post Kit</u> - Kit includes items & quantities for activation on one side of opening: (1) 4-1/2" Square Pushplate Switch (104755) (1) Post Transmitter (104753-P) (1) Single Button Post, Bronze (105380-2)	\$1,917

Post Packages



		PART NO.	QTY.	DESCRIPTION	PRICE
				<u>Double Button Wireless Post Package</u> - Package illustrates items & quantities required for activation on one side of opening:	2 @ \$234 ea
		104755	2	4-1/2" Square Pushplate Switch	\$259
		104753-P	1	Post Transmitter	\$2,022
		105396-X*	1	Double Button Post	

* Select post type and finish (See next page for more information)

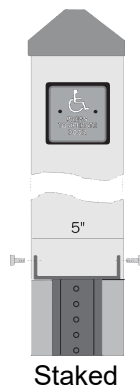
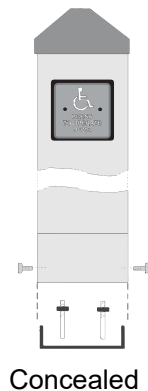
Transmitters		Price
104737-1	Handheld Remote Transmitter with 1 Button for one operator	\$216
104737-2	Handheld Remote Transmitter with 2 Buttons for two operators	\$248
104753	Clearpath Square 4-1/2" Wall Mount Transmitter	\$259
104753-J	Clearpath Jamb-Mount Transmitter	\$259
104753-P	Clearpath Post Transmitter (Transmitter only)	\$259
104753-V	Clearpath Dual Vestibule Transmitter	\$415
104753-STX	Clearpath Square 4-1/2" Sequencing Transmitter	\$309
104753-STX-J	Clearpath Jamb-Mount Sequencing Transmitter	\$370
104753-STX-P	Clearpath Sequencing Post Transmitter (Transmitter Only)	\$343
Receivers		Price
104752	Clearpath Multi-Mode Receiver	\$263
104752-RXM	Clearpath Multi-Mode Receiver w/RXM	\$349
Boxes		Price
104738-1010	Low Profile Jamb Box - 1 Box	\$102
104738-1035	Surface Mounting Jamb Box 2" deep	\$125
104738-1015	Surface Mounting Box 4-1/2" Square	\$102
104738-1020	Surface Mounting Low Profile Box 4-1/2" Square	\$125
Posts (Requires 4-1/2" Square Pushplate Switch)		Price
105380-1	Post - Aluminum Concealed (1 Pushplate switch required)	\$1,365
105380-2	Post - Bronze Concealed (1 Pushplate switch required)	\$1,365
105380-3	Post - Aluminum Staked (1 Pushplate switch required)	\$1,365
105380-4	Post - Bronze Staked (1 Pushplate switch required)	\$1,365
105380-5	Post - Aluminum Exposed (1 Pushplate switch required)	\$1,365
105380-6	Post - Bronze Exposed (1 Pushplate switch required)	\$1,365
105396-1	Post - Aluminum Concealed (2 Pushplate switches required)	\$2,022
105396-2	Post - Bronze Concealed (2 Pushplate switches required)	\$2,022
105396-5	Post - Aluminum Exposed (2 Pushplate switches required)	\$2,022
105396-6	Post - Bronze Exposed (2 Pushplate switches required)	\$2,022



Pushplate Switches

	PART NO.	DESCRIPTION	PRICE
	104755	Includes: Pushplate Switch only Pushplate Switch 4-1/2" Square Detex Logo	\$234
	104739-HSS	Includes: Pushplate Switch only Jamb Pushplate Switch 59J-HSS	\$205
	104744-HSS	Includes: Double Pushplate Switch (1) Vestibule Pushplate Switch 59V-HSS	\$421



Keyswitches - Includes Keyswitch (1) and Pushplate Switch (1)		Price
CS4730-HSS	Cylinder Keyswitch SPST Momentary HSS	\$614
CS4740-HSS	Cylinder Keyswitch DPDT Maintained HSS	\$555
Miscellaneous		Price
104790	Safety Presence Sensor (DH400)	\$1,024
105395-1	SafePath SSS-5M1 Door-Mounted Safety Sensor	\$1,391
105375-1	Rain Cover for DH Series	\$128
105378-1	Safety Beam Surface Mount	\$406
104758-1	Microwave Motion Sensor (Microstar)	\$802
104787	Door Safety Decal English	\$40
104787-1	Door Safety Decal English/Spanish	\$66
104747	Universal Time Delay Module (TDM)	\$301
104746	Infrared Motion Detector (DH100)	\$1,055
DTX-LMB-DATA	Interface Module (for use with BEA BodyGuard Presence Sensor)	\$786
Service & Repair		Price
104798-1	3-Point Push Arm Assembly AL	\$318
104798-2	3-Point Push Arm Assembly BZ	\$501
104797-1	Parallel Arm Pull Assembly AL	\$888
104797-2	Parallel Arm Pull Assembly BZ	\$1,054
104796-1	Motor / Gearbox LH Push	\$2,281
104796-2	Motor / Gearbox LH Pull	\$2,281
104796-3	Motor / Gearbox RH Push	\$2,281
104796-4	Motor / Gearbox RH Pull	\$2,281
104708	Microswitch Harness	\$125
104794	3-Position Switch & Wire	\$136
105421	Universal Controller (UDC 1000)	\$1,368
105423	Cable ISP Synchronization	\$221
106912-1	Kit 120VAC Line Filter 8-foot	\$147
106912-2	Kit 120VAC Line Filter 4-foot	\$123
106912-3	Kit 120VAC Line Filter 2-foot	\$123
105412	Push - Motor Gearbox Rebuild Kit	\$790
105412-1	Pull - Motor Gearbox Rebuild Kit	\$559
105433	S&R AO19 Clock Spring Replacement Kit	\$416

NOTES

ECL-230D SERIES



Meets ADA Requirements

 <p>Metal Photoluminescent Plate</p>	MODEL NO.	DESCRIPTION	PRICE
	ECL-230D	UL-Listed Panic Hardware Exit Control Lock	\$563
 <p>Metal Photoluminescent Plate</p> <p>NOTE: ECL-230D-PH for use on doors that require Panic Hardware</p>	ECL-230D-PH	UL-Listed Panic Hardware Standard Exit Control Lock w/Long Bar 36" to 48" Door Width	\$649
<p>Supplied with: 9-volt battery, cover lock, 2 keys, ECL-437 & ECL-439 Keepers Available in Gray or Black English paddle bar plate (ECL-8220 w/ECL-230D or ECL-2109 w/ECL-230D-PH) Rim cylinder required (see p. 94) Foreign language paddle bar plates available (see p. 87)</p>			

ECL-600 FIRE RATED HARDWARE

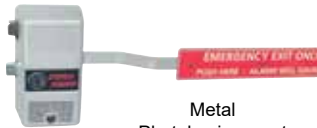
 <p>Metal Photoluminescent Plate</p>	MODEL NO.	DESCRIPTION	PRICE
	ECL-600	Warnock Hersey-Listed Fire Exit Hardware w/Long Bar 36" to 48" Door Width	\$1,064
<p>3-Hour Listing - Single Door to 4' x 8' - Double Doors to 8' x 8' Supplied with: 9-volt battery, cover lock, 2 keys Available in Gray or Black Keeper & strike kit English paddle bar plate - ECL-2109 Shipped less control cylinders Rim cylinder required (see p. 94) Foreign language paddle bar plates available - additional cost (see p. 87)</p>			

ECL-620 Outside Lever Trim for ECL-600

	MODEL NO.	DESCRIPTION	PRICE
	ECL-620	Outside Lever Trim Lever retracts latch bolt only Rim Cylinder operates deadbolt Finish: Black only Field Reversible	\$504

	MODEL NO.	DESCRIPTION	PRICE
	PP-5572	Replacement Cover Lock & 2 Keys	\$19
	ECL-405-X	Cover Lock Key X = specify Key # 11-20	\$8
	ECL-405-KIT	Set of all Cover Lock Keys Includes key numbers 11 through 20	\$29

<p>Emergency Exit Only Alarm Will Sound Push Here</p>	MODEL NO.	DESCRIPTION	PRICE
	ECL-2105K	Field Conversion Kit For 36" to 48" Door Width with metal Photoluminescent plate	\$127
	ECL-436K	Bar Guard Kit (For use with Standard ECL-230D)	\$41
	ECL-2100K	Bar Guard Kit (For use with ECL-230D-PH & ECL-600)	\$104
	ECL-475K	Decorative Back Plate Kit	\$105
	ECL-498K	Outside Pull and Warning Sign (Not for use on Fire Rated Doors)	\$245
	ECL-2111K	6V-to-9V Conversion Kit (For use with ECL-230D and ECL-230C models only)	\$152

	MODEL NO.	DESCRIPTION	PRICE
	DDH-2250	Double Door Holder (ECL-230 Series and V40 Series)	\$230

<p>(Metal Photoluminescent Plate)</p>		ECL-230D Metal Exit Bar Plates Specify:		
		ECL-8220	English (Red)	\$32
ECL-8220-1	English (Green)	\$32		
ECL-8220-6	Chinese (Red)	\$32		
ECL-8220-7	French Canadian (Red)	\$32		
ECL-8220-8	Spanish (Red)	\$32		
ECL-8220-9	Chinese (Green)	\$32		
<p>(Metal Photoluminescent Plate)</p>		ECL-230D-PH and ECL-600 Metal Exit Bar Plates Specify:		
		ECL-2109	English (Red)	\$43
ECL-2109-1	English (Green)	\$95		
106687-1	French Canadian (Red)	\$95		
106687-2	Chinese (Red)	\$95		
106687-3	Chinese (Green)	\$95		

Keeper and Strike Kits - ECL-230D

	MODEL NO.	DESCRIPTION	PRICE
	ECL-439K	Mortise Strike Plate Kit	\$85
	ECL-435K	Adjustable Surface Keeper "L" & "Z" bracket for double door applications	\$35
	ECL-437K	Adjustable Surface (standard)	\$85
All Strikes Non-Handed			

	MODEL NO.	DESCRIPTION	PRICE	
	VRA-143 (B) 84" Standard	For doors up to 84"	\$791	
	VRA-143 (C) 84" Standard	For doors up to 84"	\$834	
	VRA-143 (D) 84" Standard	For doors up to 84"	\$2,033	
	Installation Type B	Special Heights over 84" to 96"	\$959	
	Installation Type C		\$1,027	
	Installation Type D		\$1,892	
	Installation Type B	Over 96"	\$1,043	
	ECL-230D Exit Control Lock device sold separately. Specify actual door opening height up to 120". Specify type of installation to be made - B, C, or D. NOTE: VRA-143B can also be used for a single door application to provide 2-point latching.			

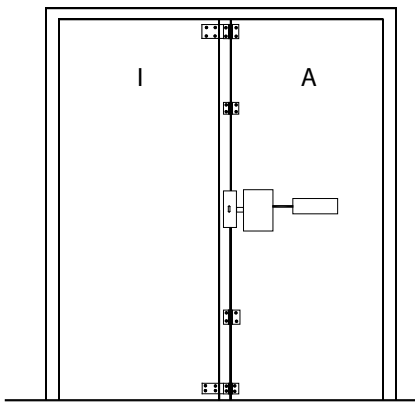

B

Application: Active Leaf Opens Both Doors
Includes one Vertical Rod Assembly for active leaf and two overlapping plates for inactive leaf

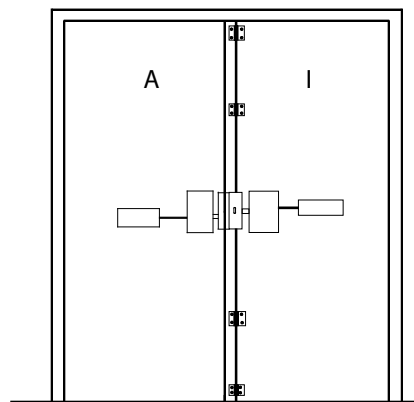

C

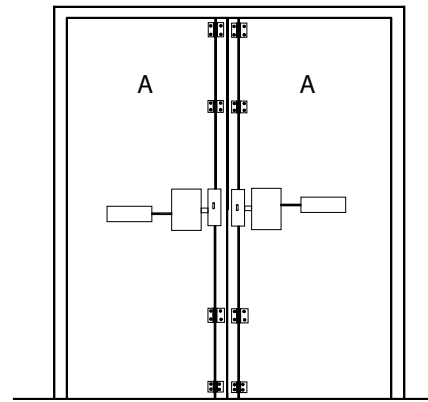

Application: Active leaf opens first; Inactive leaf remains locked until ECL-230D is activated
Includes one Vertical Rod Assembly for inactive leaf



D

Application: Each Leaf Independent
Includes two Vertical Rod Assemblies, one for each leaf



 Photoluminescent Push Plate Sign Hurricane Rating Available UL-Listed Panic Hardware	MODEL NO.	DESCRIPTION	PRICE
	ECL-230X	Single-Point Deadbolt only Exit Control Lock	\$1,160
	ECL-230X-W 	Single-Point Deadbolt only Weatherized Exit Control Lock	\$1,503

Supplied with: 9-volt battery; Optional 9VDC Power Supply see BE-961 (p. 103)
 Fits 36" - 48" Door (Standard)
 Available in Gray (Standard)
 English Push Plate Sign (RWE Standard) or
 Spanish Push Plate Sign (RWS Option) Other languages available - Call Factory
 Shipped less rim cylinder - Rim cylinder available at additional cost (see below)

OPTIONS - ECL-230X

MODEL NO.	DESCRIPTION	PRICE
H	Hurricane Rated Comes standard with SN1 (Sex Nut Kit)	Add \$325
DX1 DX2 DX3	Adds one hinge-side locking point with mounting hardware - Gray Finish Adds two hinge-side locking points with mounting hardware - Gray Finish Adds three hinge-side locking points with mounting hardware - Gray Finish Black Finish available (see p. 92)	Add \$79 Add \$142 Add \$197
30"	Fits 30" wide Door	Add \$118
RC65 IC7R	Rim Cylinder, Schlage "C" Keyway with 2 keys Installed in Lock and / or Trim Interchangeable Core Rim Cylinder Housing, Small Format Installed in Lock and / or Trim (Core not Included)	Add \$125
IP	Inside Pull	Add \$66
DDSK	Double Door Strike Kit	Add \$125
CL SS CL-SS	Cover Lock & 2 Keys (Installed) Security Screws Cover Lock & Security Screws	Add \$20 Add \$35 Add \$55
SN1	Sex Nut Kit (included with Hurricane Rated) (4 kits required)	Add \$29 (per kit)
RK	ECL-230D Retrofit Kit (Endcap plate and lock-body plate)	Add \$59

NOTE: All cylinders are keyed different. Keyed alike is available upon request.



How To Orders

ECL-230X-TD / ECL-230X-TB SERIES

Alarmed Deadbolt Panic Hardware

2-Point Locks



<p>ECL-230X-TB</p> <p>ECL-230X-TD</p> <p>Photoluminescent Push Plate Sign</p> <p>UL-Listed Panic Hardware</p>	MODEL NO.	DESCRIPTION	PRICE
	ECL-230X-TD	2-Point Top Bolt and Deadbolt Exit Control Lock	\$1,858
	ECL-230X-TB	2-Point Top and Bottom Bolt Exit Control Lock (Cover Lock standard on TB configuration)	\$2,033
	ECL-230X-W-TD	2-Point Top Bolt and Deadbolt / Weatherized Exit Control Lock	\$2,201
	ECL-230X-W-TB	2-Point Top and Bottom Bolt / Weatherized Exit Control Lock (Cover Lock standard on TB configuration)	\$2,376
<p>Supplied with: 9-volt battery; Optional 9VDC Power Supply see BE-961 (p. 103) Fits 36" - 48" Door (Standard) Available in Gray (Standard) English Push Plate Sign (RWE Standard) or Spanish Push Plate Sign (RWS Option) Other languages available - Call Factory Shipped less rim cylinder - Rim cylinder available at additional cost (see below)</p>			

OPTIONS - ECL-230X-TD / ECL-230X-TB

MODEL NO.	DESCRIPTION	PRICE
DX1	Adds one hinge-side locking point with mounting hardware - Gray Finish	Add \$79
DX2	Adds two hinge-side locking points with mounting hardware - Gray Finish	Add \$142
DX3	Adds three hinge-side locking points with mounting hardware - Gray Finish	Add \$197
	Black Finish available (see p. 92)	
30"	Fits 30" wide Door	Add \$118
RC65	Rim Cylinder, Schlage "C" Keyway with 2 keys Installed in Lock and / or Trim	Add \$125
IC7R	Interchangeable Core Rim Cylinder Housing, Small Format Installed in Lock and / or Trim (Core not Included)	
84"	Fits 6'8" to 7' Door	N/C
96"	Fits 7' to 8' Door	Add \$118
120"	Fits 8' to 10' Door	Add \$118
RC	Rod Covers	Add \$288
BG	Bottom Bolt Guard	Add \$173
RC-BG	Rod Covers & Bottom Bolt Guard	Add \$461
IP	Inside Pull	Add \$66
DDSK	Double Door Strike Kit	Add \$125
96B	Dustproof Strike (TB only)	Add \$70
96B-DDSK	Dustproof Strike & Double Door Strike	Add \$195
CL	Cover Lock & 2 Keys (Installed) (Standard on TB configuration - N/C)	Add \$20
SS	Security Screws	Add \$35
CL-SS	Cover Lock & Security Screws	Add \$55
SN1	Sex Nut Kit (TD requires 5 kits, TB requires 6 kits)	Add \$29 (per kit)
RK	ECL-230D Retrofit Kit (Endcap plate and lock-body plate)	Add \$59

NOTE: All cylinders are keyed different. Keyed alike is available upon request.

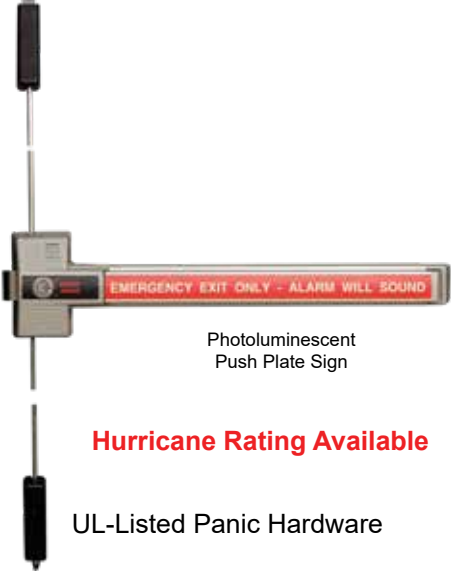



 <p>Photoluminescent Push Plate Sign</p> <p>Hurricane Rating Available</p> <p>UL-Listed Panic Hardware</p>	MODEL NO.	DESCRIPTION	PRICE
		ECL-230X-TDB	3-Point Top Bolt, Deadbolt and Bottom Bolt Exit Control Lock
	 ECL-230X-W-TDB	3-Point Top Bolt, Deadbolt and Bottom Bolt Weatherized Exit Control Lock	\$2,591
Supplied with: 9-volt battery; Optional 9VDC Power Supply see BE-961 (p. 103) Fits 36" - 48" Door (Standard) Available in Gray (Standard) English Push Plate Sign (RWE Standard) or Spanish Push Plate Sign (RWS Option) Other languages available - Call Factory Shipped less rim cylinder - Rim cylinder available at additional cost (see below)			

OPTIONS - ECL-230X-TDB

MODEL NO.	DESCRIPTION	PRICE
H	Hurricane Rated Comes standard with SN1 (Sex Nut Kit)	Add \$325
DX1 DX2 DX3	Adds one hinge-side locking point with mounting hardware - Gray Finish Adds two hinge-side locking points with mounting hardware - Gray Finish Adds three hinge-side locking points with mounting hardware - Gray Finish Black Finish available (see p. 92)	Add \$79 Add \$142 Add \$197
30"	Fits 30" wide Door	Add \$118
RC65 IC7R	Rim Cylinder, Schlage "C" Keyway with 2 keys Installed in Lock and / or Trim Interchangeable Core Rim Cylinder Housing, Small Format Installed in Lock and / or Trim (Core not Included)	Add \$125
84" 96" 120"	Fits 6'8" to 7' Door Fits 7' to 8' Door Fits 8' to 10' Door	N/C Add \$118 Add \$118
RC BG RC-BG	Rod Covers Bottom Bolt Guard Rod Covers & Bottom Bolt Guard	Add \$288 Add \$173 Add \$461
IP	Inside Pull	Add \$66
DDSK 96B 96B-DDSK	Double Door Strike Kit Dustproof Strike Dustproof Strike & Double Door Strike	Add \$125 Add \$70 Add \$195
CL SS CL-SS	Cover Lock & 2 Keys (Installed) Security Screws Cover Lock & Security Screws	Add \$20 Add \$35 Add \$55
SN1	Sex Nut Kit (included with Hurricane Rated) (6 kits required)	Add \$29 (per kit)
RK	ECL-230D Retrofit Kit (Endcap plate and lock-body plate)	Add \$59

NOTE: All cylinders are keyed different. Keyed alike is available upon request.

ECL-230X Trim

	MODEL NO.	DESCRIPTION	PRICE
		03T	Trim Plate with OKC
	01T	Trim Plate without OKC	\$269
	03PP	Pull Plate with OKC	\$269
	01PP	Pull Plate without OKC	\$269

DX Bolts

	MODEL NO.	DESCRIPTION	PRICE	
			Gray	Black
	DX1	1 Bolt and Throughbolt Mounting Hardware Available in Gray (Std.) or Black - Specify Finish	\$79	\$201
	DX2	2 Bolts and Throughbolt Mounting Hardware Available in Gray (Std.) or Black - Specify Finish	\$142	\$320
	DX3	3 Bolts and Throughbolt Mounting Hardware Available in Gray (Std.) or Black - Specify Finish	\$197	\$440

MODEL NO.	DESCRIPTION	PRICE
GTPL230X	Gate Plate Kit - Includes Gate Latch Protector (GTPLGRD), Strike Latch Receiver Bracket (GTSTKBKT), Adapter Plate (104345), Adjustable Gate Plate (GTPL)	\$1,245

MODEL NO.	DESCRIPTION	PRICE
GTPL	Adjustable Gate Plate - Fits Single Gates 32" - 52" wide Fits square or round gate frames Plate comes without mounting holes for device	\$901
GTSTKBKT	Strike Latch Receiver Bracket	\$361
104345	Adapter Plate for 230X Strike	\$127
GTPLGRD	Gate Latch Protector	\$190
03GS	Optional 03 function cylinder trim used on gates (Rim Cylinder sold separately)	\$184

All above parts available in black (specify BLK) and gray (std.) finish

For ECL-230X-W applications (further fabrication to opening required for 230X-W-TB, 230X-W-TD, 230X-W-TDB)

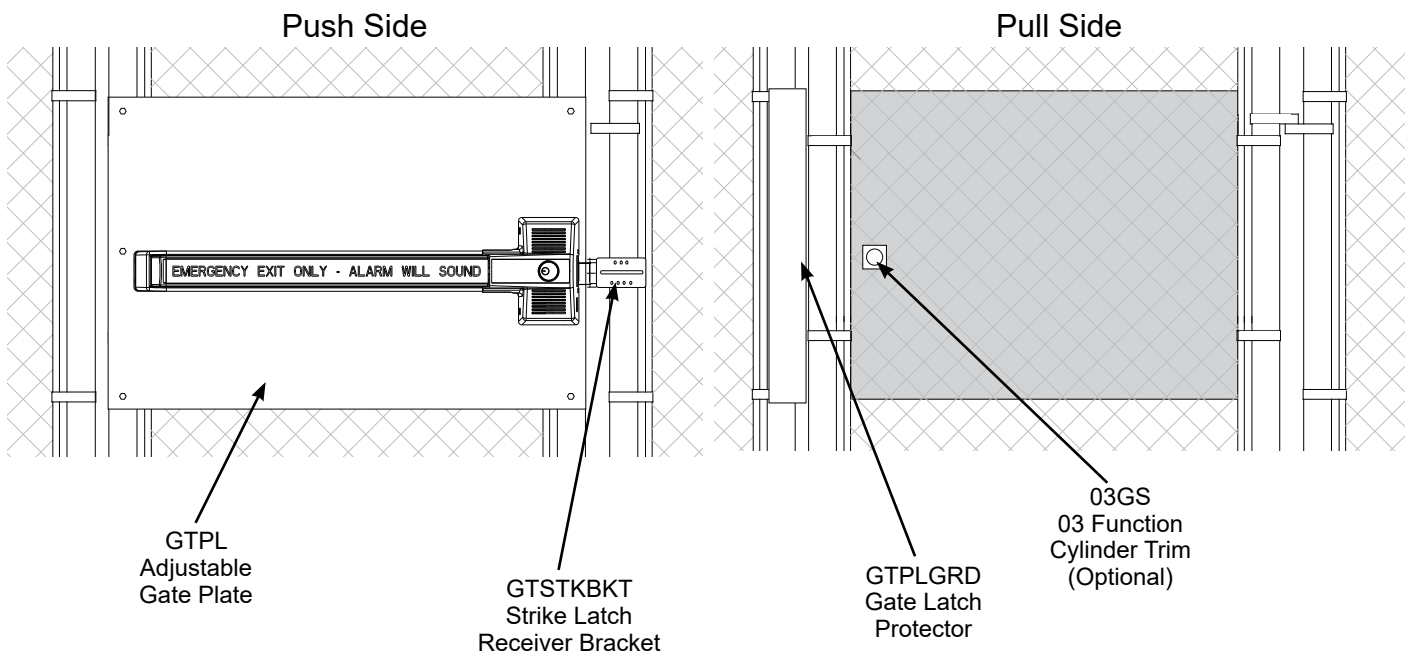

EXIT DEVICE SOLD SEPARATELY

For more information, see Exit Control Locks weatherized exit devices

Cylinders and Accessories

MODEL NO.	DESCRIPTION	PRICE	
RC65 (Also known as ECL-445K) 	Rim Cylinder, Schlage "C" Keyway with 2 keys	Cylinder only	\$63
		Pre-Installed at factory	\$125
MC65 	Mortise Cylinder, Schlage "C" Keyway, 626 Brushed Chrome Finish with 2 keys	Cylinder only	\$63
		Pre-Installed at factory	\$125
IC7 	SFIC Interchangeable Core Mortise Cylinder Housing, Small Format (Core not included)	Cylinder only	\$63
		Pre-Installed at factory	\$125
IC7R 	SFIC Interchangeable Core Rim Cylinder Housing, Small Format (Core not included)	Cylinder only	\$63
		Pre-Installed at factory	\$125
ECL-470	Extra key for RC65 or MC65 (Specify Key #)	\$22	
ECL-1595	Standard Cylinder Collars for use with ECL-230 Series & ECL-620	\$14	
CCS	Short Cylinder Collar (7/16") accommodates most 5-pin and 6-pin mortise cylinders	606, 612, 626, 630 Finishes	\$50
		605, 613, 629, 693, 695 Finishes	\$72
CCL	Long Cylinder Collar (11/16") for most 7-pin and 6- and 7-pin interchangeable core cylinders, Brushed Chrome Finish	606, 612, 626, 630 Finishes	\$54
		605, 613, 629, 693, 695 Finishes	\$70
103779 	Cylinder Nut Socket	\$66	
100783 	Cylinder Nut	\$10	
NOTE: All cylinders are keyed different. Keyed alike is available upon request.			

Rim or Mortise Cylinder?

ADVANTEX®

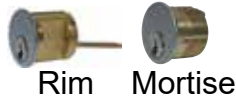

	Rim	Mortise
Cylinder Dogging (CD)		X
Electric Unlock Trim (EU)		X
Electric Unlock Trim (EU2W)		X
Electric Unlock Trim (EUV)		X
08/09D		X
08/09DN		X
08/09DNV		X
08/09DV		X
03WS	X	
03WSV	X	
03C	X	
03CN	X	
03CNV	X	
03CV	X	
03CM		X
03Z	X	
03WM		X
03R	X	
03CBK	X	
Hardwired Exit Alarm (EA)		X
Weatherized Exit Alarm with Battery (EB W)		X
Delayed Egress (EE)		X
Electric Integration (EI)		X

ECL™

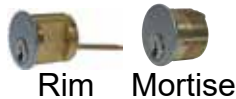

	Rim	Mortise
ECL-230D	X	
ECL-230X	X	
ECL-600	X	
ECL-620	X	

VALUE SERIES®

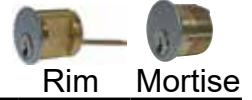

	Rim	Mortise
Cylinder Dogging (CD)		X
03WS	X	
03P	X	
03PN	X	
03A	X	
03AN	X	
08/09BN		X
Electric Unlock Trim (EU2W)		X
Hardwired Exit Alarm (EA)		X
Exit Alarm with Battery (EB)		X
Weatherized Exit Alarm with Battery (EB W)		X
Delayed Egress (EE)		X

EAX®

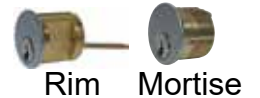

	Rim	Mortise
EAX-500		X
EAX-2500		X
EAX-3500		X
EAX-4200	X	
EAX-300		X

90 SERIES

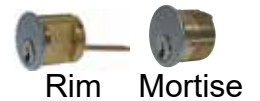

	Rim	Mortise
(F)90KR	X	

Miscellaneous

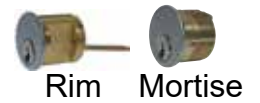

	Rim	Mortise
CS-400		X

MODEL NO.	DESCRIPTION	PRICE
EAX-500	Surface Mount Battery Alarm (Sensor Kit & EA-561 Warning Sign Included) Gray Finish - standard	\$366
EAX-500SK1 EAX-500SK2 EAX-500SK3 EAX-500SK4 EAX-500SK5 EAX-500SK6	Kit Includes 1 EAX-500 alarm and: (1) MS-1039S Magnetic Switch (2) MS-1039S Magnetic Switches (1) MS-1059S Magnetic Switch (2) MS-1059S Magnetic Switches (1) MS-2049S Magnetic Switch (2) MS-2049S Magnetic Switches	Add \$96 Add \$190 Add \$96 Add \$190 Add \$171 Add \$341
EAX-500W	Weatherized Surface Mount Battery Alarm	\$531
EAX-500 Series is UL-Classified Miscellaneous Fire Door Accessories		



Mortise
Cylinder
Sold
Separately

MAP Policy Applies
See page 9



NOTE - Cylinders not included. Products on this page can be ordered with cylinders (MC65) or Interchangeable core housings (IC7) pre-installed at Detex prior to shipping (see page 94).

CONFIGURABLE OPTIONS - EAX®-500

MODEL NO.	DESCRIPTION	PRICE
BK	Suffix for black finish	No Additional Cost
EA-561 EA-704-2 102651-1 EA-705 EA-561G 102651-3 102651-2	Self-Adhesive Door Signs English - Red (RWE) Spanish - Red (RWS) French - Green (GWF) French Canadian - Red (RWF) German - Green (GWG) Chinese - Red (RWC) English/German - Green (GWE)	No Additional Cost when ordered with EAX
KS	Keystop, factory-installed	Add \$11
L11 thru L20	Cover lock with specific key number (EAX-500 only)	No Additional Cost
102644	In-Swing Door Kit	\$33
SI	Status Indicator	Add \$11

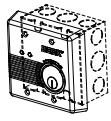
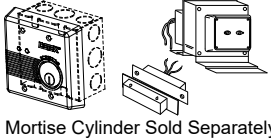

How To Orders

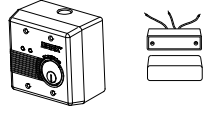
	MODEL NO.	DESCRIPTION	PRICE
 Mortise Cylinder Sold Separately	EAX-2500F	Flush Mount AC/DC-Powered Alarm Gray Finish (std.) (EA-561 Warning Sign and Back Box Included) - Does not include, but requires Magnetic Door Contacts (p. 100) and Transformer (p. 103)	\$642
 Mortise Cylinder Sold Separately	EAX-2500FK	Kit - Flush Mount AC/DC-Powered Alarm Gray Finish (std.) (EA-561 Warning Sign, Back Box, flush magnetic switch contact and 24VAC Transformer Included)	\$956
 Mortise Cylinder Sold Separately	EAX-2500S	Surface Mount AC/DC-Powered Alarm Gray Finish (std.) (EA-561 Warning Sign and Back Box Included) - Does not include, but requires Magnetic Door Contacts (p. 100) and Transformer (p. 103)	\$642
 Mortise Cylinder Sold Separately	EAX-2500SK	Kit - Surface Mount AC/DC-Powered Alarm Gray Finish (std.) (EA-561 Warning Sign, Back Box, surface magnetic switch contact and 24VAC Transformer Included)	\$914



NOTE - Cylinders not included. Products on this page can be ordered with cylinders (MC65) or Interchangeable core housings (IC7) pre-installed at Detex prior to shipping (see page 94).

CONFIGURABLE OPTIONS - EAX®-2500

MODEL NO.	DESCRIPTION	PRICE
BK	Suffix for black finish	No Additional Cost
EA-561 EA-704-2 102651-1 EA-705 EA-561G 102651-3 102651-2	Self-Adhesive Door Signs English - Red (RWE) Spanish - Red (RWS) French - Green (GWF) French Canadian - Red (RWF) German - Green (GWG) Chinese - Red (RWC) English/German - Green (GWE)	No Additional Cost when ordered with EAX
KS	Keystop, factory-installed	Add \$11
C	Conversion kit for retrofit from EA-2500F (102640)	Add \$96
SI	Status Indicator	Add \$11
277	277V Transformer (FK and SK versions only)	Add \$208
L9	No Battery Backup	Add \$11
T	Tamper Switch	Add \$33

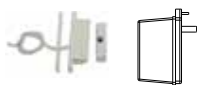

How To Orders

 <p>Mortise Cylinder Sold Separately</p>	MODEL NO.	DESCRIPTION	PRICE
	EAX-3500	24VAC/DC Hardwired Timed Bypass Exit Alarm with Rechargeable Battery (EA-561 Warning Sign Included) Does not include, but requires: Magnetic Door Contacts - See p. 101 24V Transformer - See p. 103	\$1,496
	EAX-3500FK	 Kit - 24VAC/DC Hardwired Timed Bypass Flush Exit Alarm with Rechargeable Battery, Flush Door Contacts, Plug-in Transformer	\$1,717
	EAX-3500SK	 Kit - 24VAC/DC Hardwired Timed Bypass Surface Exit Alarm with Rechargeable Battery, Surface Door Contacts, Plug-in Transformer	\$1,758

NOTE - Cylinders not included. Products on this page can be ordered with cylinders (MC65) or Interchangeable core housings (IC7) pre-installed at Detex prior to shipping (See page 94).

CONFIGURABLE OPTIONS - **EAX®-3500**

MODEL NO.	DESCRIPTION	PRICE
EA-561 EA-704-2 102651-1 EA-705 EA-561G 102651-3 102651-2	Self-Adhesive Door Signs English - Red (RWE) Spanish - Red (RWS) French - Green (GWF) French Canadian - Red (RWF) German - Green (GWG) Chinese - Red (RWC) English/German - Green (GWE)	No Additional Cost when ordered with EAX

ACCESSORIES - **EAX®-3500**

MODEL NO.	DESCRIPTION	PRICE
CL-1	Cover Lock Key (key only)	\$10
102966	Lock Cam & Key	\$22
BR12	Rechargeable Battery 12VDC, 3.4AH	\$121
103952-1	6VDC Rechargeable Battery	\$80
103945	Allows EAX-3500 Surface Alarm to be recessed into hollow wall construction Kit includes: Flush Box, Instructions and Mounting Hardware	\$141

 <p>Mortise Cylinder Sold Separately</p>	MODEL NO.	DESCRIPTION	PRICE
	EAX-300	Surface Mount Battery-Powered 100dB Door Prop Alarm with Internal Magnetic Door Contacts and Back Box Available in: Gray or Black	\$391
	EAX-300SK1 EAX-300SK2 EAX-300SK3 EAX-300SK4 EAX-300SK5 EAX-300SK6	Kit Includes 1 EAX-300 alarm and: (1) MS-1039S Magnetic Switch (2) MS-1039S Magnetic Switches (1) MS-1059S Magnetic Switch (2) MS-1059S Magnetic Switches (1) MS-2049S Magnetic Switch (2) MS-2049S Magnetic Switches	Add \$96 Add \$190 Add \$96 Add \$190 Add \$171 Add \$341
	EAX-300W	Weatherized Door Prop Alarm	\$556



NOTE - Cylinders not included. Products on this page can be ordered with cylinders (MC65) or Interchangeable core housings (IC7) pre-installed at Detex prior to shipping (See page 94).

CONFIGURABLE OPTIONS - **EAX®-300**





MODEL NO.	DESCRIPTION	PRICE
BK	Suffix for black finish	No Additional Cost
EA-561 EA-704-2 102651-1 EA-705 EA-561G 102651-4 102651-3 102651-2	Self-Adhesive Door Signs English - Red (RWE) Spanish - Red (RWS) French - Green (GWF) French Canadian - Red (RWF) German - Green (GWG) Chinese - Green (GWC) Chinese - Red (RWC) English/German - Green (GWE)	No Additional Cost when ordered with EAX
KS	Keystop, factory-installed	Add \$11
SI	Status Indicator	Add \$11





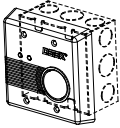

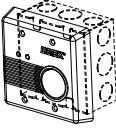





How To Orders



	EAX-411SK	Surface Mount AC/DC 85dB Door Prop Alarm Kit (Back Box, Surface Magnetic Switch Contacts and 24VAC Transformer Included)	\$717
	EAX-4200SK	Surface Mount AC/DC 85dB Exit Alarm/ Door Prop Alarm Kit (Back Box, Surface Magnetic Switch Contacts, 24VAC Transformer and rim cylinder Included)	\$1,785

REMOTE ALARMS

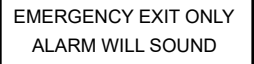
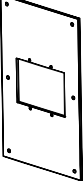

	MODEL NO.	DESCRIPTION	PRICE
	CS940F CS950F	Flush Mount 9VDC Battery-Powered Remote Alarm No cylinder required Available in: Gray (CS940F) or Black (CS950F)	\$249
	CS940S CS950S	Surface Mount 9VDC Battery-Powered Remote Alarm No cylinder required Available in: Gray (CS940S) or Black (CS950S)	\$249
	CS2940F CS2950F	Flush Mount Externally-Powered Remote Alarm with 9VDC battery backup. AC adapter included - No cylinder required Available in: Gray (CS2940F) or Black (CS2950F)	\$358
	CS2940S CS2950S	Surface Mount Externally-Powered Remote Alarm with 9VDC battery backup. AC adapter included - No cylinder required Available in: Gray (CS2940S) or Black (CS2950S)	\$358

	MODEL NO.	DESCRIPTION	PRICE
	MS-1039F	Economical Magnetic Switch Flush Mount, White, Closed Contacts	\$55
	MS-1039S*	Economical, Balanced Magnetic Switch Surface Mount, White, Closed Contacts	\$96
	MS-1059F	Economical Magnetic Switch Flush Mount, Brown, Closed Contacts	\$55
	MS-1059S*	Economical, Balanced Magnetic Switch Surface Mount, Brown, Closed Contacts	\$96
	MS-2049F**	Heavy Duty Form C Magnetic Switch (Flush Mount)	\$226
	MS-2049S**	Heavy Duty Form C Magnetic Switch (Surface Mount)	\$281
	MS-2049SC**	Heavy Duty Form C Magnetic Switch (Surface/Conduit Mount)	\$419
	MS-2049SI	Heavy Duty Form C Magnetic Switch (Surface Inswinging Mount)	\$233
<p>* Meets UL 634 Level 2 High-Security Sensor Standard ** UL-Classified Miscellaneous Fire Door Accessories</p>			

	MODEL NO.	DESCRIPTION	PRICE
	PP-5572	Replacement Cover Lock & 2 Keys	\$19
	ECL-405-X	Cover Lock Key X = specify Key # 11-20	\$8
	ECL-405-KIT	Set of all Cover Lock Keys Includes key numbers 11 through 20	\$29

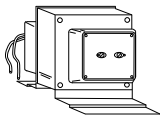
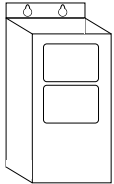
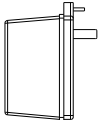

	Self-Adhesive Door Signs - Pricing for additional Self-Adhesive Door Signs not ordered with EAX		
	EA-561 EA-704-2 102651-1 EA-705 EA-561G 102651-4 102651-3 102651-2	English - Red (RWE) Spanish - Red (RWS) French - Green (GWF) French Canadian - Red (RWF) German - Green (GWG) Chinese - Green (GWC) Chinese - Red (RWC) English/German - Green (GWE)	\$10 \$19 \$19 \$19 \$19 \$19 \$19 \$19
	102644	In-Swing Door Kit (For use with EAX-500 and EAX-300)	\$33
	102640	Conversion Kit for Retrofit from EA-2500F to EAX-2500F Size: 11" x 6.5" x 0.16" Aluminum Plate Includes: Anchors, Screws and Instructions	\$95
	PP-5567	9V Battery	\$14

POWER SOURCES



	MODEL NO.	DESCRIPTION	PRICE
	BE-961-1	Battery Eliminator - 120VAC to 9VDC Includes 10' Flex Conduit and Transformer Powers up to 3 ECLs or 3 EBs	\$407
	BE-961-2	Battery Eliminator - Same as above with Supervisory Loop Power, Transformer, Flex Conduit, alarm and LED (For use with ECL-230 & ECL-600 Series only)	\$467
	BE-961-5	Battery Eliminator - 12VAC to 9VDC Does not include Transformer or Flex Conduit Powers up to 3 ECLs or 3 EBs	\$285
	BE-961-6	Battery Eliminator - 24VAC to 9VDC Does not include Transformer or Flex Conduit Powers up to 3 ECL-230X-W or 3 EBs	\$285
		106595-5	Battery Eliminator in NEMA enclosure - 120VAC to 9VDC Includes 10' Flex Conduit and Transformer Powers up to 3 ECLs or 3 EB Ws
	PP-5152-2	Transformer, 120VAC - 24VAC 40 VA-60Hz	\$127
	PP-5152-3	Transformer, 120VAC - 12VAC 25 VA-60Hz	\$59
	PP-5452-2	Transformer, 240VAC - 12VAC, 25VA-50Hz	\$165
	106021	Transformer, 277VAC TO 24VAC 75VA	\$180
	106530	Transformer 277VAC to 110V/240VAC 500VAC	\$598
	PS-P12x2-120	Plug-In Power Supply 120VAC - 12VDC 2 Amps	\$125
	PS-P24x1-120	Plug-In Power Supply 120VAC - 24VDC 1 Amp	\$167

AT-5000 SERIES™

TAILGATE DETECTION

	MODEL NO.	DESCRIPTION	PRICE
	AT-5200-R0	Tailgate Detection System	\$13,451
	AT-5600-R0	Tailgate Detection System With Voice Alarm 3 second standard message	\$13,583

OPTIONS

	MODEL NO.	DESCRIPTION	PRICE
	R1	Status Indicator with single-gang mounting plate	Add \$594
	R2	Status Indicator with mullion mounting plate	Add \$662
	106969	Spacer kit for AT-5200 and AT-5600	\$1,488



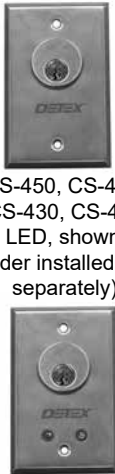

KEYSWITCHES

 <p>CS-450, CS-460, CS-430, CS-440 (No LED, shown with cylinder installed - sold separately)</p> <p>CS-452, CS-462, CS-432, CS-442 (2 LEDs - red & green, shown with cylinder installed - sold separately)</p>	MODEL NO.	DESCRIPTION	PRICE
	CS450	Keyswitch, single, momentary, no LED	\$280
	CS452	Keyswitch, single, momentary, 2 LEDs (green - red)	\$280
	CS460	Keyswitch, single, maintained, no LED	\$280
	CS462	Keyswitch, single, maintained, 2 LEDs (green - red)	\$280
	CS430	Keyswitch, 2 switches, momentary, no LED	\$280
	CS432	Keyswitch, 2 switches, momentary, 2 LEDs (green - red)	\$280
	CS440	Keyswitch, 2 switches, maintained, no LED	\$280
	CS442	Keyswitch, 2 switches, maintained, 2 LEDs (green - red)	\$280
NOTE: Single-switch back box not included; requires mortise cylinder (see p.94)			



KEYSWITCH COVERS

	MODEL NO.	DESCRIPTION	PRICE
	PC1	Keyswitch Cover & Adapter Plate	\$159

PUSH BUTTONS

	MODEL NO.	DESCRIPTION	PRICE
	PB-2138-3	Shroud, beige, terminals, form C, single-gang	\$567
	PB-2158-3	Shroud, aluminum, terminals, form C, mullion-mount	\$441
	PB-2048-3	Mushroom, aluminum, terminals, form C, single-gang	\$540
NOTE: Single-switch back box not included			

ELECTRIC STRIKES

	MODEL NO.	DESCRIPTION	PRICE
	DS-24	12/24V AC/DC For Rim Exit Device	\$1,703
	DS-24W	12/24V DC, Weatherized For Rim Exit Device	\$1,703
	DS-24W-KIT	Includes Weatherized Electric Strike, Gate Box and Angle Bracket For Rim Exit Device	\$1,846

RELAY KITS

MODEL NO.	DESCRIPTION	PRICE
RLY12	12 VAC Relay Kit For use with 12V alarms that have remote bypass feature. Used with remote bypass to shunt alarm and activate another electrified device. Separate J-Box required	\$111
RLY24	24 VAC Relay Kit For use with 24V alarms that have remote bypass feature. Used with remote bypass to shunt alarm and activate another electrified device. Separate J-Box required	\$132

POWER TRANSFERS / ELECTRIC HINGE

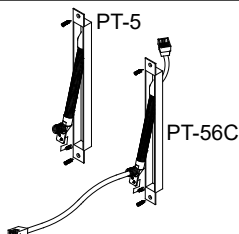
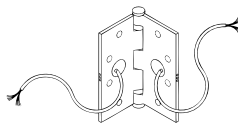
	MODEL NO.	DESCRIPTION	PRICE
	PT-5	Power Transfer - 628 Finish	\$230
	PT-56C	Power Transfer with 6-Pin Connector and Insulated Cable	\$357
	EWH8-626	4.5" x 4.5", 8 wires Standard Weight Electric Hinge	\$551



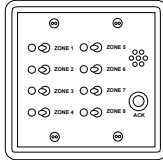
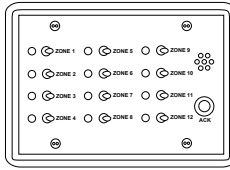

REMOTE INDICATING PANELS

	MODEL NO.	DESCRIPTION	PRICE
	RP-621*	2-Gang Switch Box Wall Mount 8-Zone Annunciator w/Shunt 12VDC	\$2,484
	RP-631*	3-Gang Switch Box Wall Mount 12-Zone Annunciator w/Shunt 12VDC	\$4,348
*Units do not come with Back Box supplied. Fits standard 2- or 3-gang electrical box.			

MOTION SENSORS

	MODEL NO.	DESCRIPTION	PRICE
	MN01	Motion Detector, 12/24VDC, form C relay	\$441
	MN02	Motion Detector, 9-16VDC, form A relay (N.O.)	\$111

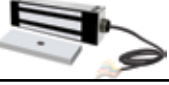
ELECTROMAGNETIC LOCKS

	MODEL NO.	DESCRIPTION	PRICE
	ML-1548	1500 lbs, 12/24VDC, Surface	\$993
	ML-1548RT	1500 lbs, 12/24VDC, Timer (0-30 seconds)	\$1,513
	ML-1549W	Weatherized	\$1,013
	ML-1549WF	Weatherized, Face Mount	\$1,013

SIREN

	MODEL NO.	DESCRIPTION	PRICE
	SRN5W	Detex siren, weatherized, no lettering, back box, 2-wire, 12/24VDC	\$844

Helpful Links

To contact Detex technical support

www.detex.com/support

To contact Detex customer service

www.detex.com/contact

To find your nearest domestic representative

www.detex.com/ reps

To find your nearest international representative

www.detex.com/ ireps

To view the online price list (PDF & Excel available)

www.detex.com/ pricing

To view all How To Order pages

www.detex.com/ hto

To see the trade shows we will be attending

www.detex.com/ trade-shows

**For the most up-to-date price list
visit www.detex.com/pricing**

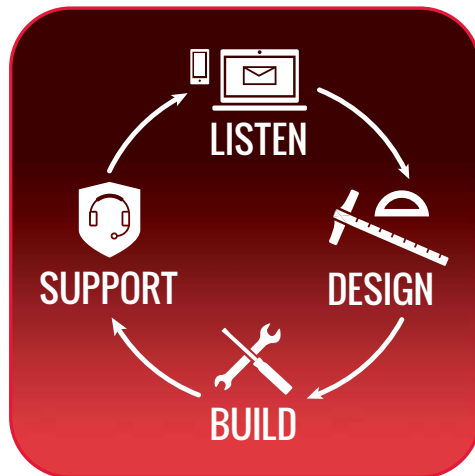

How To Orders

DETEX[®]

Detex Corporation

302 Detex Drive
New Braunfels, Texas 78130-3045 USA

PH: (830) 629-2900

(800) 729-3839

FAX: (800) 653-3839

<http://www.detex.com>

USA Sales:

marketing@detex.com

International Sales:

export@detex.com